

ecoAIR+ PRO range (G3)



**EN**

## **TECHNICAL MANUAL Outdoor units**

**MODEL:**

**SERVICE CONTACT:**



# Contents

<b>1. General information .....</b>	<b>2</b>
1.1. Safety considerations.....	2
<b>2. Heat pump installation (outdoor unit) .....</b>	<b>9</b>
2.1. Transport and handling.....	9
2.2. Dimensions and connections .....	9
2.3. Unpacking .....	10
2.4. Assembly and disassembly of the covers .....	11
2.5. Location and assembly.....	12
2.6. Service areas .....	14
<b>3. Hydraulic installation .....</b>	<b>15</b>
3.1. General instructions.....	15
3.2. Hydraulic connection between the Hidrokit indoor unit and the outdoor unit .....	15
3.3. Hydraulic connection between the Hidrokit Compact indoor unit and the outdoor unit.....	16
3.4. Hydraulic connection using an ecoAIR CM and ecoAIR CM Lite indoor unit.....	17
<b>4. Filling and discharging the circuits.....</b>	<b>19</b>
<b>5. Electrical system .....</b>	<b>20</b>
5.1. General instructions.....	20
5.2. Power supply.....	21
5.3. External protections.....	22
<b>6. Communication bus between the outdoor and the indoor unit.....</b>	<b>23</b>
6.1. Communication between outdoor module and Hidrokits and ecoAIR CM .....	23
6.2. Communication between outdoor module and indoor unit ecoAIR CM Lite.....	23
<b>7. Technical specifications .....</b>	<b>25</b>
7.1. Component location .....	25
7.2. Electrical power diagrams .....	30
7.3. Electrical connection tables .....	33
7.4. Hydraulic operational area.....	34
<b>8. Operation map .....</b>	<b>36</b>
<b>9. Operation curves .....</b>	<b>38</b>
<b>10. Technical data table .....</b>	<b>40</b>
<b>11. Symbols .....</b>	<b>42</b>



## 1. General information



- This manual contains the necessary information to install the heat pump. Read this manual carefully before installing the equipment. Keep this manual handy for future reference.

This manual contains two different kinds of warnings that should be heeded.



**NOTE**

- Indicates a situation that may cause material damage or equipment malfunction. This may also be used to indicate practices that are recommended or not recommended for the equipment.



**DANGER!**

- **W**arning of imminent or potential danger which, if not avoided, may result in injury or even death. This may also be used to warn of unsafe practices.

The outdoor units, ecoAIR+ heat pumps, must be installed with CM or Hidrokit or Hidrokit Compact indoor units. Together, they have been designed to function within heating systems, cooling systems, to produce domestic hot water (DHW), pool heating or other similar uses. The manufacturer is not responsible for any material damage and/or personal injury resulting from improper use or incorrect installation of the equipment.

The modules must be installed by an authorised technician following local regulations and according to the instructions described in this manual.

### 1.1. Safety considerations

The detailed instructions in this section cover important safety aspects and must therefore be strictly complied with.



**DANGER!**

- **A**ll the installation and maintenance work described in this manual must be performed by an authorised engineer.
- **D**o not allow children to play with the modules.
- **C**hildren should not clean or maintain the heat pump without adult supervision.
- **I**mproper installation or use of the equipment could cause electrocution, short circuits, leakage of working fluids, fire or other personal injuries and/or material damage.
- **I**f you are unsure of the procedures for installation, maintenance or use of the equipment, contact your local dealer or technical support for advice.
- **I**f you detect a malfunction in the module, contact your local dealer or technical support to answer any questions.
- **W**hen carrying out installation, maintenance, or commissioning of the heat pump, always use appropriate personal protective equipment.
- **K**eeep the plastic bags included in the packaging out of the reach of children, as improper use could result in injury caused by asphyxia.

**Refrigerant**

Ecoforest heat pumps may contain different types of refrigerants depending on the model. The refrigerants used by Ecoforest are not harmful to the environment as they do not contain chlorine and therefore do not contribute to the destruction of the ozone layer. Refer to the label on your heat pump to identify which refrigerant it contains. You can use the following table to check their flammability and toxicity characteristics.

Refrigerant	GWP	Flammability, see label	
R290	3	A3	

**Table 1.1.** Flammability and toxicity properties of refrigerants used by ecoAIR+ heat pumps.

Under normal operation of the heat pump the toxicity of the refrigerant is nil and there is no risk of explosion. However, the following precautions should be taken in the event of refrigerant leakage.



- **T**he refrigerant contained inside the heat pump must not be released into the atmosphere as it contributes to global warming (GWP).
- **T**he refrigerant should be recovered for recycling or elimination according to current legislation.
- **D**o not directly touch the area where the leakage has occurred, as this could result in severe frostbite injuries.
- **V**entilate the area immediately.
- **M**ake sure that the area in which the heat pump is installed is properly ventilated before you open the module’s refrigerant circuit.
- **K**eep the area ventilated while performing maintenance or repair operations.
- **A**nyone who has come into contact with refrigerant vapour must evacuate the area immediately and breathe fresh air.
- **A1** refrigerants: Direct exposure of the refrigerant to a flame produces toxic gas. However, this gas can be detected by its odour when at concentrations well below the permitted limits.
- **A3** refrigerants: Do not allow any source of ignition to come into contact with the refrigerant. When searching for a refrigerant leakage, use means that do not involve a naked flame. If you use an electronic detector, it must be designed to detect the refrigerant used by the module. You can also use liquid detectors, but make sure that the detergents in these liquids do not contain Chlorine which can corrode copper piping. Please remember that refrigerants may not give off any odour.

In addition to the above recommendations, please observe the following precautions when carrying out maintenance and repair work.



**DANGER!**

- **B**efore carrying out any work on the refrigerant circuit, the power supply must be disconnected.
- **D**o not pierce or burn any pipes that contain refrigerant until the equipment has been discharged.
- **D**o not carry out maintenance work in enclosed spaces. If necessary, switch off the heat pump and carry out repairs in an adjacent well-ventilated room.
- **A**ll maintenance work must be carried out by an authorised installer in accordance with the applicable local regulations governing work involving refrigerants, and with the instructions contained in this manual. In addition, everyone involved in maintenance work must be aware of the hazards associated with working with refrigerants.
- **A**lways follow the maintenance and service guidelines in this manual. If in doubt, contact Ecoforest's technical department for assistance.
- **T**he work area must be checked with a refrigerant detector, appropriate to each type of refrigerant, before and during any tasks that require the use of a flame or any other form of heat input to avoid creating explosive atmospheres. To ensure that the gas concentration is a maximum of 25% of the lowest combustible concentration (Lower Flammability Limit, LII) of the refrigerant used, the leakage detection equipment must be configured and calibrated for the refrigerant used.
- **N**o one carrying out work on a refrigeration system that involves exposing piping should use any source of ignition in such a way as to create a risk of fire or explosion.
- **M**ake sure that CO<sub>2</sub> extinguishing equipment is on hand before starting work involving heat input.
- **C**heck that there are no sources of ignition, including cigarettes, while performing maintenance and repair work on the equipment.
- **B**efore any work is carried out, you must inspect the area around the equipment to ensure that there are no flammable hazards or any risk of ignition. "No smoking" signs shall be put in place.
- **I**f you suspect a leak, all naked flames must be eliminated / extinguished.
- **I**f you discover a refrigerant leak requiring soldering, all refrigerant must be recovered from the system. Do not apply a flame until the circuit is completely empty.
- **M**ake sure that any replacement components in the refrigerant circuit are supplied or approved by Ecoforest.
- **D**o not apply any permanent inductive or capacitive charge to the heat pump.
- **I**n the presence of a flammable atmosphere, do not activate any component of the heat pump.

- 
- **I**f there is a problem that might compromise safety, do not connect the heat pump to any power supply until it has been satisfactorily resolved. If the problem cannot be corrected immediately, but it is nonetheless necessary to continue with the operation, a suitable temporary solution, agreed with Ecoforest's technical department, must be used. This must be reported to the owner of the equipment so that all parties can be informed.
  - **N**ever modify safety features such as pressure switches or refrigerant circuit sensors.
  - **M**ake sure that the recovery and vacuum equipment is suitable for working with the refrigerant used in the module, and that it is in good condition.
  - **A**t the end of the repair, leave all components (insulation, fasteners and cables) in the same condition as when you found them. In the event of any damage, replace the element in question.
  - **W**hen starting up the module, make sure that the condensers are discharged: do this in a safe manner to avoid the possibility of causing sparks.
  - **M**ake sure that no active electrical wiring or components are left exposed while charging, recovering, or pumping out the system.
  - **M**ake sure that grounding continuity is maintained throughout maintenance and repair work.
  - **D**o not use any means to accelerate defrosting processes or to clean the battery other than those recommended by Ecoforest.
- 

When performing work on a refrigerant circuit, follow these brief guidelines:

1. Remove the refrigerant.
2. Purge with Nitrogen (N<sub>2</sub>).
3. Pump out the module.
4. Purge the circuit and spray the area where the opening is to be carried out with Nitrogen (N<sub>2</sub>).
5. Open the circuit with a blowtorch or by cutting.
6. Carry out the repair work.
7. Close and pressurise with Nitrogen (N<sub>2</sub>) to check for the presence of leaks.
8. Pump out the module.
9. Fill it with the amount of refrigerant indicated on the product label.



Observe the following warnings during the recovery and charging processes:



- 
- **W**hen transferring refrigerant to recovery cylinders, make sure that only suitable refrigerant recovery cylinders are used. Make sure that the correct number of cylinders are available to hold the total system charge. All cylinders to be used are designed for the refrigerant being recovered and labelled for that refrigerant (i.e., special refrigerant recovery cylinders). Cylinders must be complete with a pressure relief valve and associated cut-off valves in good working order. Empty recovery cylinders should be evacuated and, if possible, cooled before recovery takes place.
  - **T**he recovery equipment must be in good working order and a set of instructions for the equipment must be to hand. It must be suitable for the recovery of all appropriate refrigerants, including, where applicable, flammable refrigerants. A set of calibrated scales must also be available and in good working order. Hoses must be complete with disconnect couplings free of leaks and in good condition. Before using the recovery machine, check that it is in good working order, that it has been properly maintained and that all associated electrical components are sealed to prevent ignition in the event of refrigerant being released. If in doubt, ask the manufacturer.
  - **T**he recovered refrigerant shall be returned to the refrigerant supplier in the correct recovery canister and an appropriate waste transfer note shall be provided. Do not mix refrigerants in recovery modules and particularly not in recovery cylinders.
  - **I**f you are going to remove a compressor or compressor oil, make sure that it has been evacuated to an acceptable level to ensure that no flammable refrigerant remains within the lubricant. Evacuate the compressor before you return it to the suppliers. To speed up this process, only heat the compressor body by electrical means. When draining oil from a system, do so in a safe manner.
  - **M**ake sure that the different refrigerants are not contaminated when using the charging equipment. Keep hoses or lines as short as possible to minimise the amount of refrigerant they contain.
  - **K**eep the recovery tanks in an appropriate position as per the instructions.
  - **M**ake sure that the refrigeration system is grounded before charging the system with refrigerant.
  - **T**ake great care not to overfill the refrigeration system.
  - **T**he system must be tested for leaks when charging has been completed but before start-up. A leak test should be carried out before the equipment is left to operate normally.
- 

#### Hydraulic installation

Installation and subsequent interventions on hydraulic circuits must only be performed by authorised personnel in accordance with applicable local regulations and the instructions provided in this manual.



- 
- **D**o not touch any of the internal components during or immediately after heat pump operation; this can result in burns caused by cold or heat. If these components need to be touched, allow sufficient time for the temperatures to stabilise and wear protective gloves to avoid injury.
-

**Water quality**

Take the corrosion behaviour of the circuits and the DHW tank into account. If you are not sure about the quality of the water available for filling the system, analyse it. In the following tables you can check the water quality level requirements for the production circuit.

Water components	Concentration in mg/l	Water components	Concentration in mg/l
Alkalinity	$\text{HCO}_3^- < 70$	Free carbon dioxide	$\text{CO}_2 < 5$
Sulphur	$\text{SO}_4^{2-} < 70$	Nitrate	$\text{NO}_3^- < 100$
Alkalinity / Sulphur	$\text{HCO}_3^- / \text{SO}_4^{2-} > 1$	Iron	$\text{Fe} < 0.2$
Ammonium	$\text{NH}_4 < 2$	Aluminium	$\text{Al} < 0.2$
Free chlorine	$\text{Cl}_2 < 1$	Manganese	$\text{Mn} < 0.1$
Hydrogen sulphur	$\text{H}_2\text{S} < 0.05$	Chloride	$\text{Cl}^- < 300$

**Table 1.2.** Concentration limits of water elements for production and brine circuits.

Water properties	Limit values
pH	$7.5 < \text{pH} < 9$
Hardness	$4 < \text{dH} < 8.5$
Electrical conductivity	$10 < \mu\text{S}/\text{cm} < 500$

**Table 1.3.** Water property limits for production and brine circuits.



**DANGER!**

- **R**isk of damage due to unsuitable water.
- **D**eposits caused by the use of unsuitable water can damage the brine source, the pipes, the heat exchangers and the DHW tank of the heat pump.
- **T**he use of sea water is not permitted.
- **T**he quality of the drinking water must comply with the applicable regional regulations and the instructions in this manual.

**Electrical system**

Any intervention on the electrical system must only be performed by an authorised electrician in accordance with applicable local regulations and the instructions provided in this manual.



**DANGER!**

- **T**he heat pump has more than one electrical power supply.
- **T**he heat pump must be supplied with an external switch that can cut off all the circuits. Ecoforest recommends that you install one automatic external switch for each power supply (indoor unit control, internal ancillary module, outdoor unit control and outdoor unit inverter).
- **B**efore performing any operation on the electrical panel, disconnect the power supply.
- **D**uring installation and maintenance of the module, never leave the electrical panel unattended while it is exposed.
- **D**o not touch any component of the electrical panel with wet hands as this could cause an electric shock.

**Disposal**



- This device should not be treated as household waste.
- At the end of its useful life, dispose of the device properly in accordance with local regulations and in an environmentally friendly way.

The heat pump contains refrigerant R290. This refrigerant does not harm the environment, but once its useful life cycle is over, the refrigerant must be recovered so that it can be recycled or disposed of in accordance with current regulations.

Please read the following warnings carefully before disposal:



- **F**amiliarise yourself with the equipment and its use.
- **E**lectrically isolate the system.
- **B**efore you begin the procedure, make sure that you have the necessary mechanical equipment to handle the refrigerant tank. Also make sure that all necessary personal safety equipment is available and used properly. Finally, make sure that the recovery process is continuously supervised by an authorised person and that the recovery equipment and tanks comply with the appropriate standards.
- **P**ump out the refrigerant system, if possible. If it is not possible to pump it out, create a branch so that the refrigerant can be recovered from different parts of the system.
- **C**heck that the refrigerant tank is on the scale before you start to recover it. Start up the recovery device and recover according to the manufacturer's instructions.
- **D**o not overfill the cylinders (max. 80% of liquid content volume).
- **D**o not exceed the maximum permissible working pressure of the cylinders, even temporarily.
- **W**hen the cylinders have been correctly filled and the process is complete, close all cut-off valves on the equipment and remove the cylinders and equipment from the installation immediately.
- **T**he recovered refrigerant must not be poured into any other system before it has been cleaned and inspected.
- **T**he equipment must be marked to indicate that it has been taken out of operation and emptied of refrigerant. The marking must be dated and signed. Check that the equipment is marked to indicate that it contains flammable refrigerant.

## 2. Heat pump installation (outdoor unit)

### 2.1. Transport and handling

The heat pump (outdoor unit) must be transported vertically and not exposed to adverse weather conditions. It can be lain carefully on its rear side to facilitate transportation to the installation site.



**NOTE**

- Do not tilt the outdoor unit more than 45° to the vertical; doing so may cause the module to malfunction.
- Due to the heavy weight of the module, it should be handled by at least two workers using a forklift for heavy loads.

### 2.2. Dimensions and connections

The overall dimensions and the hydraulic connections of the outdoor units are set out below.

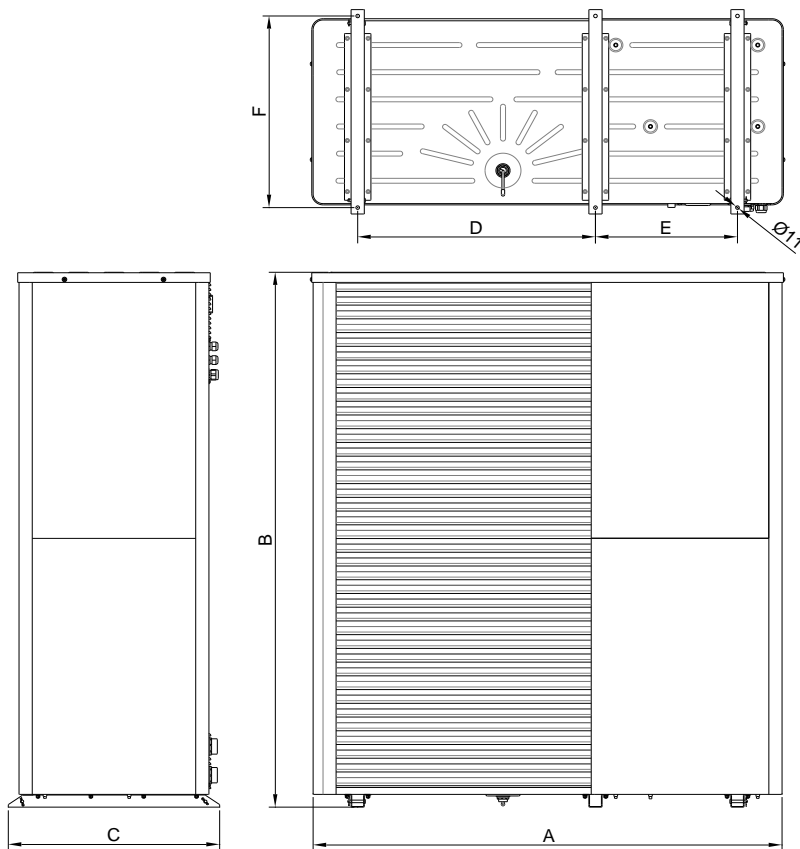

Figure 2.1. Overall dimensions of ecoAIR+ outdoor units.

MODEL	A	B	C	D	E	F	G	H	I
ecoAIR+ 400 6-24 PRO	1430	1675	640	720	430	600	100	90	105

Table 2.1. Key to the overall dimensions of ecoAIR+ outdoor units (mm).

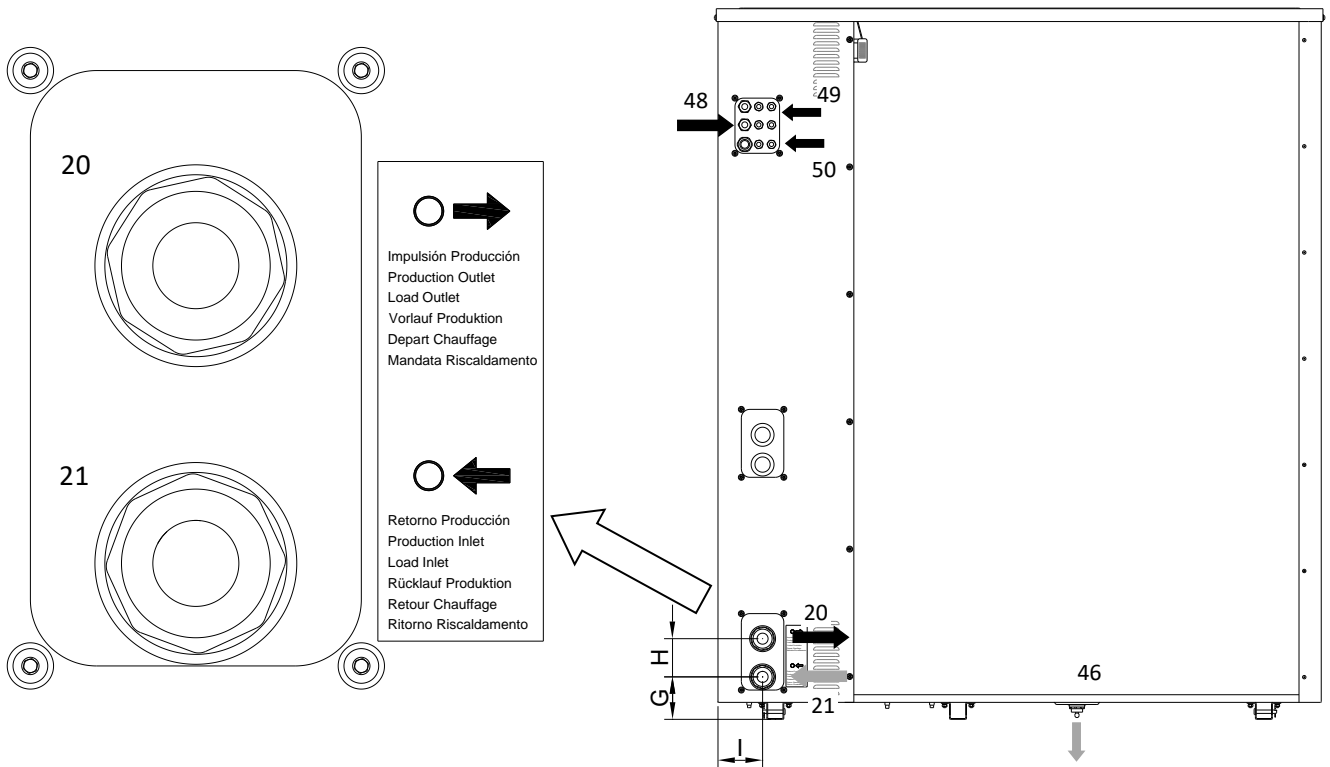

Figure 2.2. Overall dimensions and hydraulic connections of ecoAIR+ outdoor units.

No	Description	ecoAIR+ 400 6-24 PRO
20	Production supply	G1-1/2" Male
21	Production inlet	G1-1/2" Male
46	Drain	G3/4" Male
48	Table of electrical connections	
49	Power cables inlet	
50	Control cables inlet	

Table 2.2. Key to the electrical and hydraulic wiring of ecoAIR+ outdoor units.

### 2.3. Unpacking

When unpacking the outdoor unit carefully remove the box and check that the module has not been damaged during its transportation. Remove the anchor screws from the pallet.

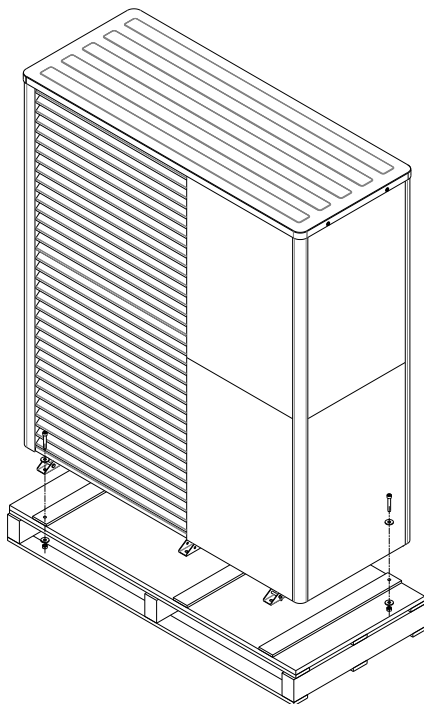

Figure 2.3. Disassembly of the screws that attach the outdoor unit to the pallet.

#### 2.4. Assembly and disassembly of the covers

A 4 mm Allen wrench is needed to assemble and disassemble the covers. Disassemble the cover of the electrical connections. Remove the four screws and pull the cover.

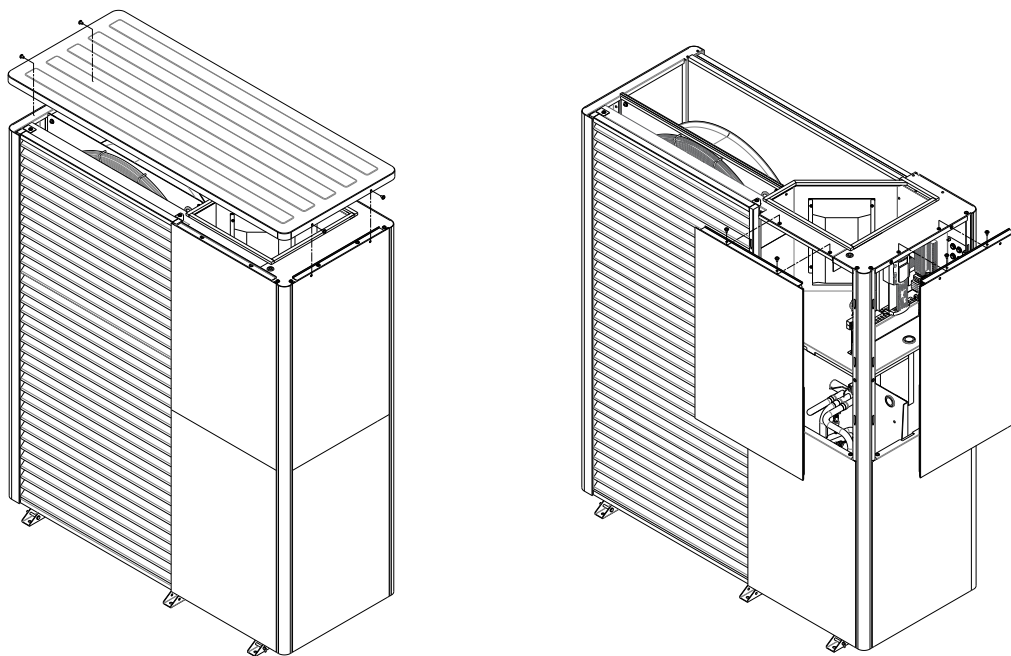

Figure 2.4. Opening the cover of the electrical connections.

A 4mm Allen wrench is needed to access the inside of the module.

1. Disassemble the top cover. Loosen the screws located on the sides of the cover and pull upwards.
2. Disassemble the front cover. Remove the screws located at the upper part and pull upwards.
3. Disassemble the side cover. Remove the screws located at the upper part and pull upwards.

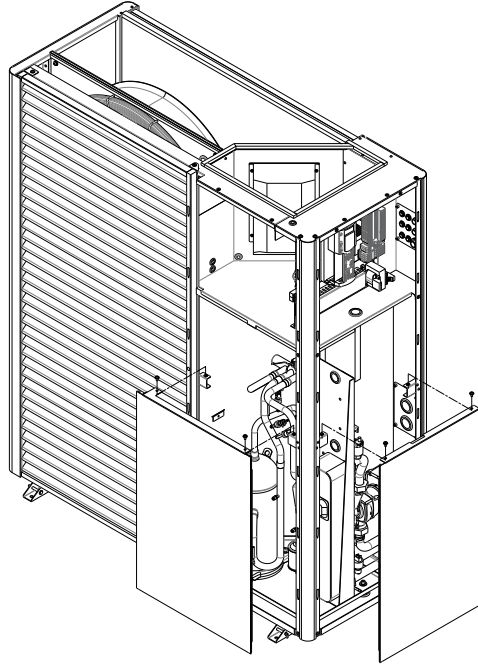

Figure 2.5. Opening the covers to access the cooling module.

## 2.5. Location and assembly

The outdoor unit must be installed outside the building. Therefore, they are equipped with a corrosion resistant finish and the electrical panel is covered entirely by a watertight cover. Follow the recommendations below to choose the proper location:

- Choose a well-ventilated place to facilitate air circulation. If the module is installed in poorly ventilated places, such as corners, small open spaces or between walls, the exhaust air may be recirculated as intake air, drastically reducing heat pump efficiency.
- Do not attempt to guide the air that enters or exits the module. The module must be installed on the outside with no ducts of any description and following the minimum distances specified in figure 2.9.
- Choose a place where there is no risk that the air suction system will be obstructed by foliage, snow, etc.
- Do not install the module in a place where the wind blows directly on the fan area. This may affect its performance.
- Note that when the module fan is operating it can produce annoying noises both in your own home and in your neighbours' homes. Do not install the module near windows of bedrooms and at least 3 metres from pathways.
- The final location must be accessible for maintenance tasks.

The module must be securely mounted. To do so, take the following steps:

- Fasten the module to a firm surface capable of withstanding the weight, vibrations and wind bursts without lifting up, moving or sinking.
- Install the 4 silent blocks provided with the heat pump onto the 4 fastening holes. The silent blocks must be perfectly secured both to the base and to the module either with screws, nuts or another mechanical means.
- Level the module so the top plate is perfectly horizontal, and the side plates are completely vertical.

Up to 6 litres of water can be released during defrosting cycles. Install an adequate system to evacuate this water, taking the following points into account:

- Make sure not to spill this water on surfaces with no drainage, such as asphalt, tiles, etc. This water may freeze due to low temperatures and make people slip and fall.
- If the module is installed on a surface that does not drain, place a pipe to channel the defrost water from the module outlet to the nearest drain. Figures 2.7 and 2.8 show several proposed systems to evacuate the water, depending on the support system.
- Make sure the water does not freeze in the drainpipe, since this could obstruct it. The edge of the defrost heater of the tray itself can be found at the drain outlet you will find at the bottom of the module. Pull on this heater until some 50cm protrude. This section of the heater must be installed inside the drainage tube to avoid freezing.
- If a siphon has to be installed, place it where it is not affected by freezing temperatures, as shown in figures 2.6 and 2.7.

Check and comply with local regulations governing the assembly of the outdoor unit.

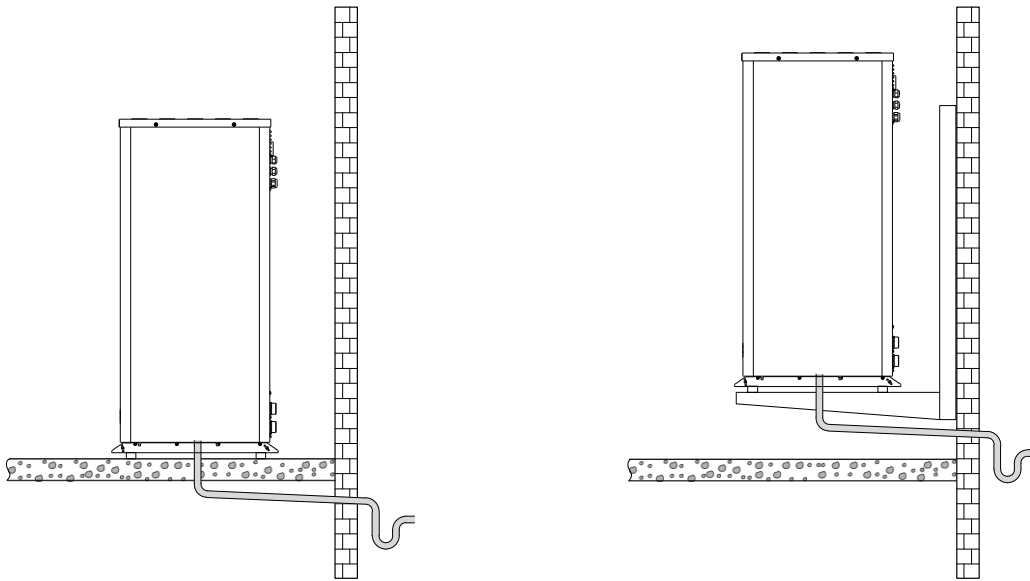

Figure 2.6. Support systems with the tray connected to the drain.

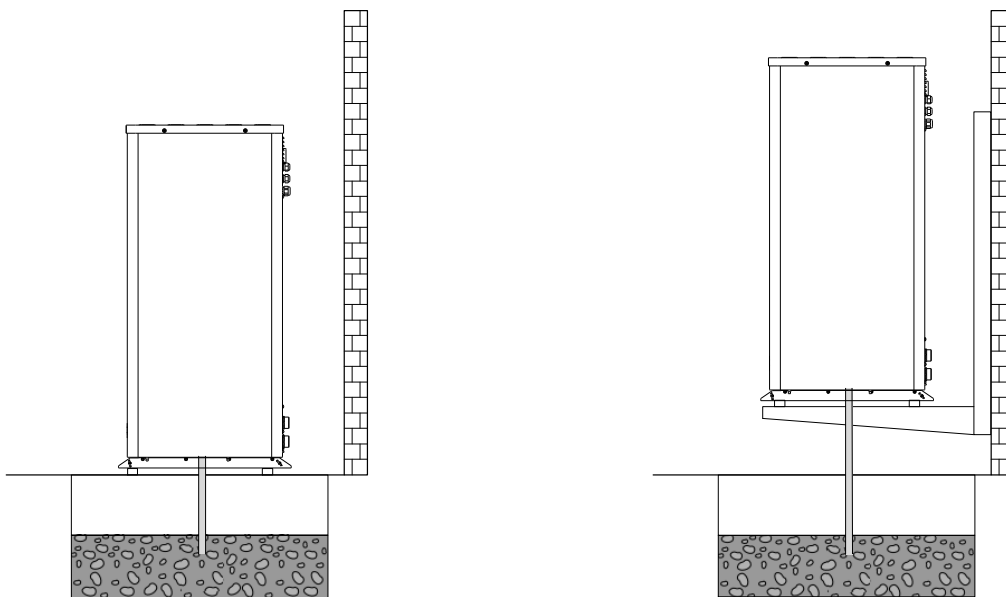

Figure 2.7. Support system with tray connected to a layer of gravel to drain the water.



## 2.6. Service areas

The minimum recommended distances to be left around the module to allow an adequate flow of air and to facilitate installation, start-up and maintenance work are indicated below.

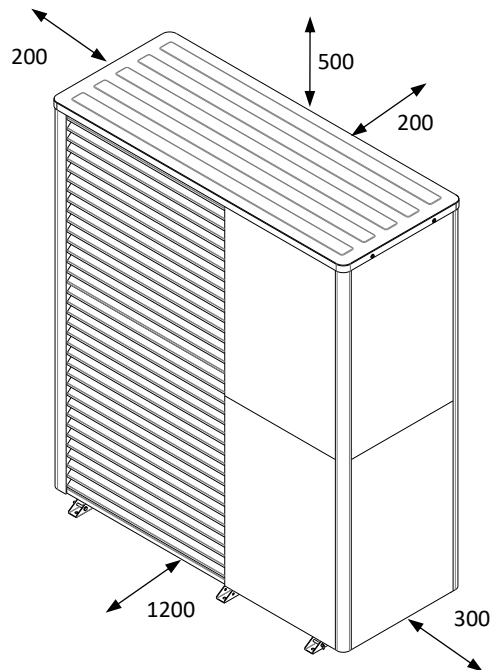

Figure 2.8. Areas of minimum service around the module (dimensions in mm).



- Due to the refrigerant R290, it is not recommended that the rear and/or sides of the heat pump be completely attached to walls or other obstacles, as in the event of leakage, the refrigerant must be allowed to escape.



- Pay special attention, both when designing the piping layout and when positioning the heat pump, to allow easy access to the cover hardware and convenient access to the internal components of the heat pump.

### 3. Hydraulic installation



**NOTE**

- The installation diagrams included from here on should be considered simply as a guide.
- The design of the hydraulic installation must be performed by qualified personnel and in accordance with applicable local regulations.
- The design of the hydraulic installation must guarantee the minimum required flow rate through the heat pump at all times; otherwise, it could lead to equipment malfunction or even breakage.

#### 3.1. General instructions

The following recommendations should be taken into consideration for proper hydraulic installation.

- Avoid excessive strain between the pipes and the connections and the modules to avoid leakage and/or the transmission of vibrations. Flexible hoses are recommended when wiring the outdoor unit.
- Install cut-off valves at all the hydraulic connections to facilitate future maintenance tasks.
- Install traps at all the installation points where air pockets can form.
- Place heat insulation on all circuit pipes to prevent unnecessary heat loss and possible condensation.



**DANGER!**

- **D**uring installation work on the hydraulic circuits, take special care to prevent liquid from spilling on the internal electrical heat pump components of the modules, which could cause personal injury due to electrocution and/or poor equipment operation.
- **D**o not install components that might cover the inlet or outlet of the safety valves; this could lead to a risk of some of its components breaking and cause injuries and/or material damage.
- **N**ecessary to install automatic drains outside, to prevent refrigerant leaks through the hydraulic circuit, inside the house.

#### 3.2. Hydraulic connection between the Hidrokit indoor unit and the outdoor unit

Connect an outlet and an inlet pipe between the Hidrokit indoor unit and the outdoor unit as shown in Figure 3.1.

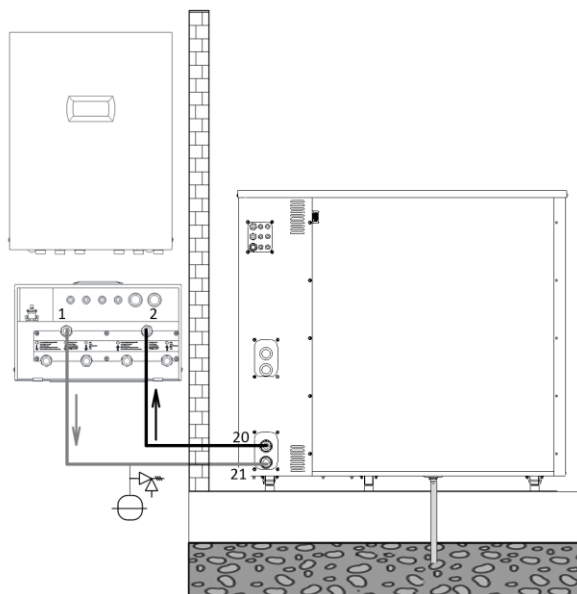

**Figure 3.2.** Connection diagram between the Hidrokit indoor unit and the outdoor unit.

### Integrated components

The outdoor unit comprises the following components of the production circuit:

- Variable speed and high efficiency pump (energy class A).
- Drain valve.

Hidrokit indoor units comprise the following components of the production circuit:

- Filter valve.
- Filling / discharge valve.
- Outlet and return temperature sensors.
- Exchanger of heat glycol mixture / water (only in the Hidrokit HK-EH-S indoor unit).
- Variable-speed and high-efficiency pump (only in the Hidrokit HK-EH-S indoor unit).

### Installation instructions

When wiring the Hidrokit indoor unit and the outdoor unit, bear in mind the following guidelines.

- Install a pressure control system on each circuit as per local regulations. This system shall be both an expansion vessel and a safety valve.
- If you are installing a Hidrokit HK-EH-S indoor unit, install particulate filters on the heating and DHW inlet pipes with a mesh size not greater than 1 mm. It is recommended that you install cut-off valves immediately before and after the filter to make it easier to clean or replace them.
- The pressure of the circuit must have a value of between 0.7 and 2 bar gauge (70 and 200 kPa).
- The design of the hydraulic installation must always guarantee the minimum required flow rate through the heat pump (see section 10). For more information on the design of the hydraulic installation, refer to the manual of the indoor unit of the heat pump.

### 3.3. Hydraulic connection between the Hidrokit Compact indoor unit and the outdoor unit

Connect an outlet and an inlet pipe between the Hidrokit Compact indoor unit and the outdoor unit as shown in figure 3.2.

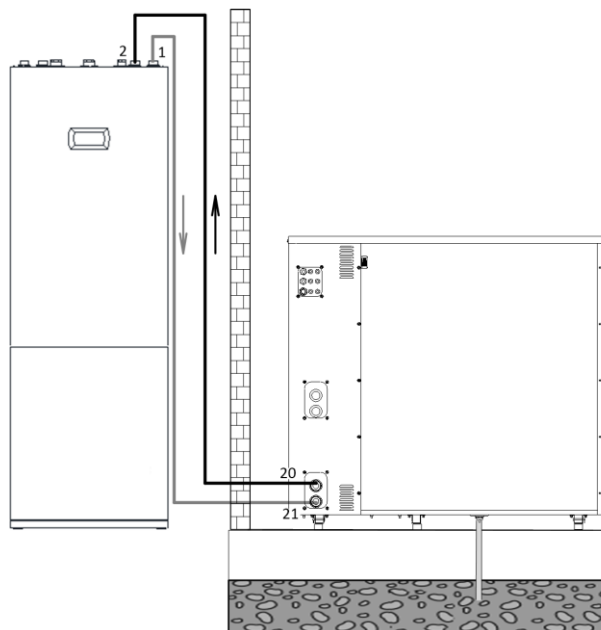

**Figure 3.3.** Connection diagram between the Hidrokit Compact indoor unit and the outdoor unit.

### Integrated components

The outdoor unit comprises the following components of the production circuit:

- Variable speed and high efficiency pump (energy class A).
- Drain valve.

Hidrokit Compact indoor units comprise the following components of the production circuit:

- Filter valve.
- Filling / discharge valve.
- Outlet and return temperature sensors.
- DHW storage tank, 165 l.
- 12 l expansion vessel, with a preset pressure of 1.3 bar (1.3 MPa), heating circuit.
- Safety valves set at 3 bar gauge (3 MPa) (the Hidrokit Compact HK-EH-S indoor unit has two)
- 8 l expansion vessel, with a preset pressure of 0.75 bar (0.75 MPa) (only in the Compact HK-EH-S indoor unit).
- Exchanger of heat glycol mixture / water (only in the Hidrokit Compact HK-EH-S indoor unit).
- Variable-speed and high-efficiency pump (only in the Hidrokit Compact HK-EH-S indoor unit).

### Installation instructions

When wiring the Compact indoor unit and the outdoor unit, bear in mind the following guidelines.

- Check that the volume of the expansion vessel integrated in the Hidrokit Compact indoor unit is capable of absorbing any overpressures from the circuit. If this volume is not enough, install a supplementary external expansion vessel.
- If necessary, adjust the pressure of the expansion vessel integrated in the Hidrokit Compact indoor unit to guarantee that the circuit remains pressurised at all points.
- The pressure of the circuit must have a value of between 0.7 and 2 bar gauge (0.7 and 2 MPa).

### 3.4. Hydraulic connection using an ecoAIR CM and ecoAIR CM Lite indoor unit

The indoor units ecoAIR CM and ecoAIR+ CM Lite, are only control modules at different levels. Therefore, connect the installation directly to the outdoor unit. In figure 3.3 you can see an example of an ecoAIR CM indoor unit.

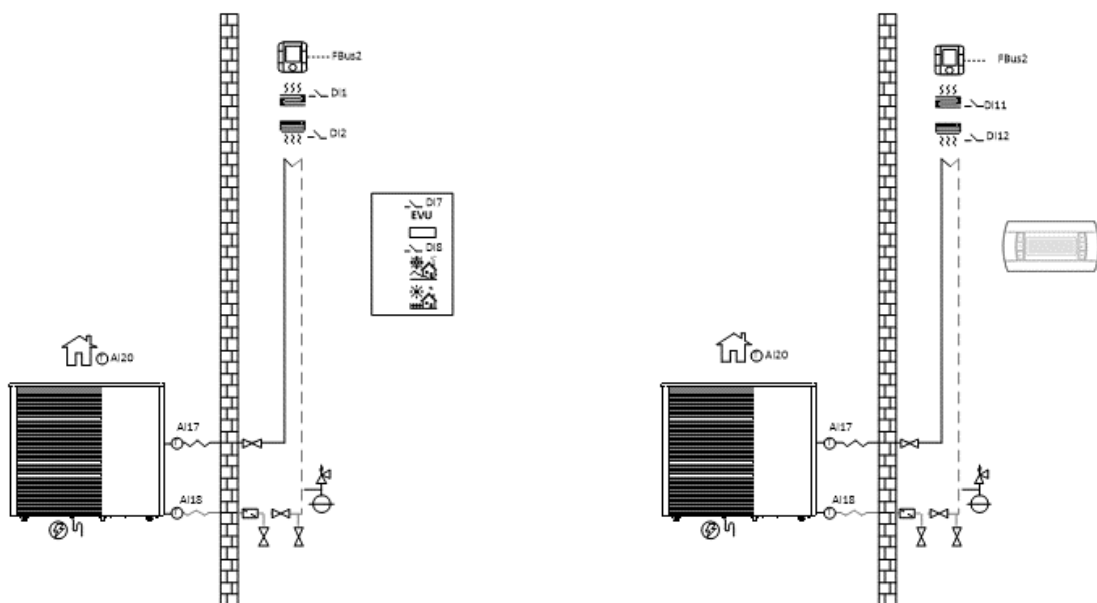

Figure 3.4. Connection diagram with an ecoAIR CM and ecoAIR CM Lite indoor unit.

**Integrated components**

The outdoor unit comprises the following components of the production circuit:

- Variable speed and high efficiency pump (energy class A).
- Drain valve.

**Installation instructions**

When carrying out the hydraulic wiring between the outdoor unit and the installation, bear in mind the following guidelines.

- Install a pressure control system on each circuit as per local regulations. This system shall be both an expansion vessel and a safety valve.
- Install a particulate filter in the return pipe with a mesh size no greater than 1 mm. It is recommended that you install cut-off valves immediately before and after the filter to make it easier to clean or replace them.
- Install the necessary components to carry out the filling/discharge of the return pipe.
- The pressure of the circuit must have a value of between 0.7 and 2 bar gauge (70 and 200 kPa).
- Internal outlet and return temperature sensors may be installed as an option.

## 4. Filling and discharging the circuits

---



**DANGER!**

- During filling work on the hydraulic circuits, take special care to prevent liquid from spilling on the internal electrical heat pump components, which could cause personal injury due to electrocution and/or poor equipment operation.
- 



**NOTE**

- If the outside temperatures were to fall below 0°C at any time, it is recommended that you fill the outdoor unit with an antifreeze mixture. The freezing temperature of this mixture must be less than the minimum temperature that may be reached in the area.
  - Fill the circuits so that they are completely purged. Failure to do so may cause the modules and indeed the entire installation to malfunction.
- 

The outdoor unit is equipped with internal drain valves that ensure complete discharge of the various internal circuits. For more information on filling and discharging the circuits, refer to the manual of the indoor unit.

## 5. Electrical system



- Before performing any operation on the electrical panel, disconnect the power supply.
- Remember that the heat pump has more than one electrical power supply.
- Ecoforest recommends installing an automatic external switch for each electrical power supply (control and inverter).
- Any intervention on the electrical system must only be performed by an authorised electrician in accordance with applicable local regulations and the instructions provided in this manual.
- The cables used to connect the heat pump must comply with applicable national regulations.
- Install cables entering the heat pump in such a way that they have no tension, cannot become corroded, are not affected by vibration and do not touch sharp edges.
- Install power cables so that the ground cable is at least 50mm longer than the rest of the cables, to ensure that it is the last cable to be disconnected in case of accidental disconnection.

### 5.1. General instructions

The locations of the main components of the electrical connections panel are shown below.

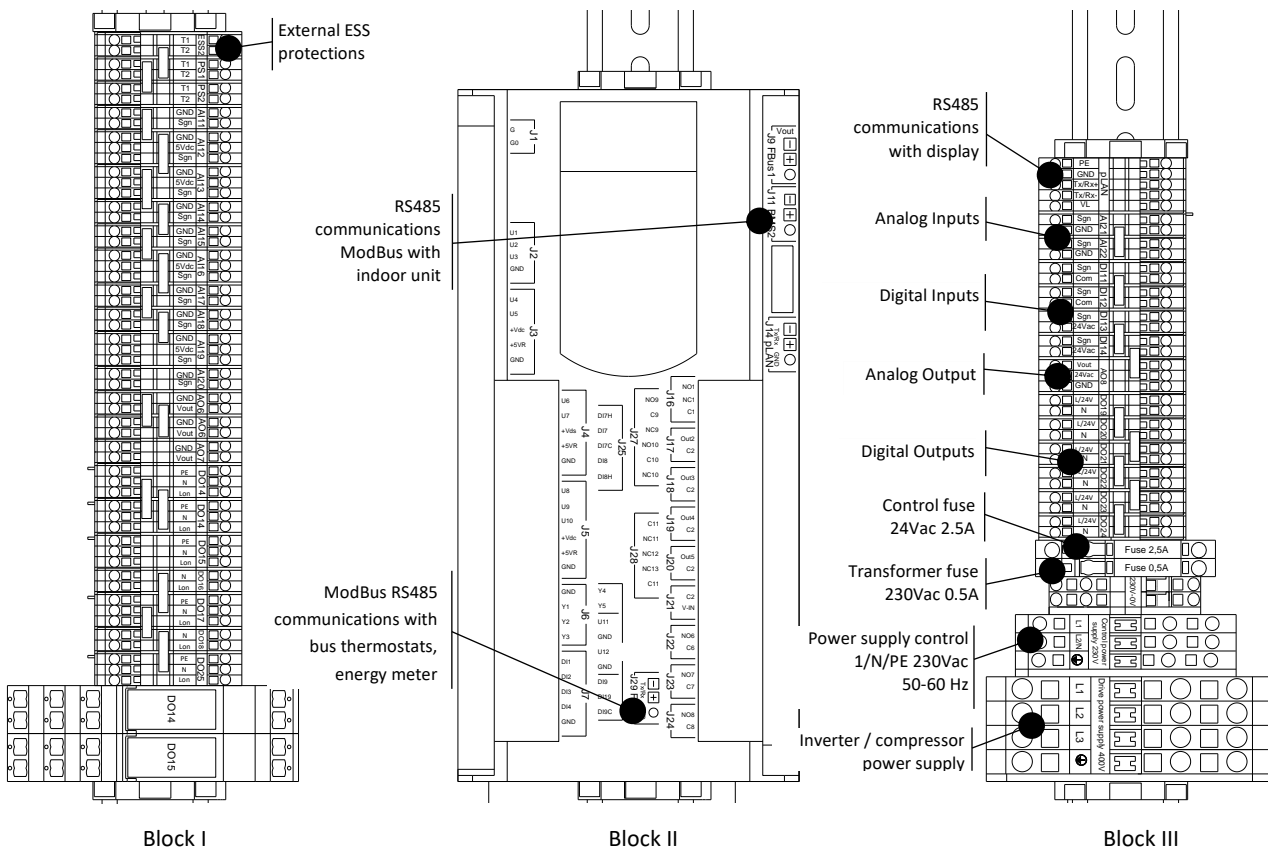

Figure 5.1. Location of the components in the outdoor unit electrical panel.

## 5.2. Power supply

The outdoor unit requires two power supply points. One for the power supply of the control, including in this module the power supply of the circulators and/or the internal and external valves and also the regulation signals, and the digital and analog inputs. The other power supply is exclusively dedicated to the compressor. Heat pumps must be powered via an automatic external differential switch which switches off all the circuits and which detects at least alternating or pulsating leakage currents with or without a continuous component, i.e., a type A or A HI component ( $\Delta$ ). In addition to the differential switch mentioned above, the heat pump must be protected by an external thermal-magnetic switch.

### Power supply of the control panel

The following table shows the characteristics of the necessary electrical connection:

Type of power supply	Type of protection/ Cut-off current	Recommended cable section
1/N/PE 230 V / 50-60 Hz	Magnetic, thermal and differential / 5A	1 mm <sup>2</sup>

Table 5.1. Characteristics of the power supply of the control of the outdoor unit.

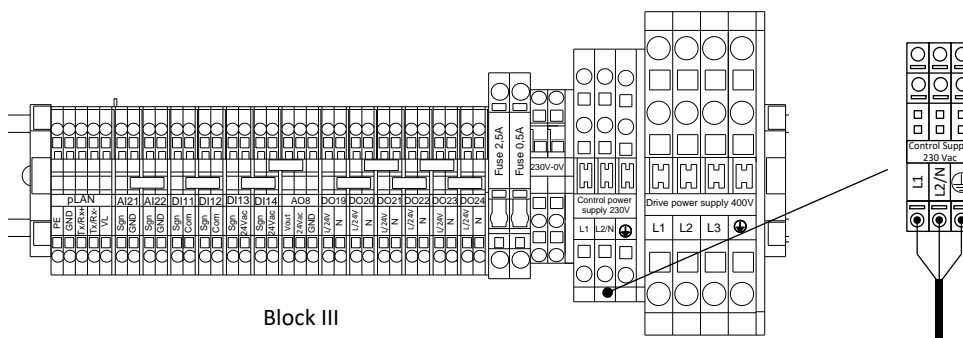

Figure 5.2. Connection scheme of the power supply of the control of the outdoor unit.

### Power supply of the compressor

The power supply of the compressor, depending on the model, may require either a single-phase or a three-phase power supply. The following table shows the characteristics of the necessary electrical connection:

Models	Type of power supply	Type of protection/ Cut-off current	Recommended cable section
ecoAIR+ 400 6-24 PRO	3/PE 400 V / 50-60 Hz	Magnetic, thermal and differential / 32 A	6 mm <sup>2</sup>

Table 5.2. Characteristics of the power supply of the control of the outdoor unit.

To carry out the electrical installation, open the rear cover of the electrical connections panel. Introduce the power cable through the compression gland and tighten it, making sure that the joint between the compression gland and the cable is watertight. Then connect the cables to the power terminal block of the compressor as shown below.



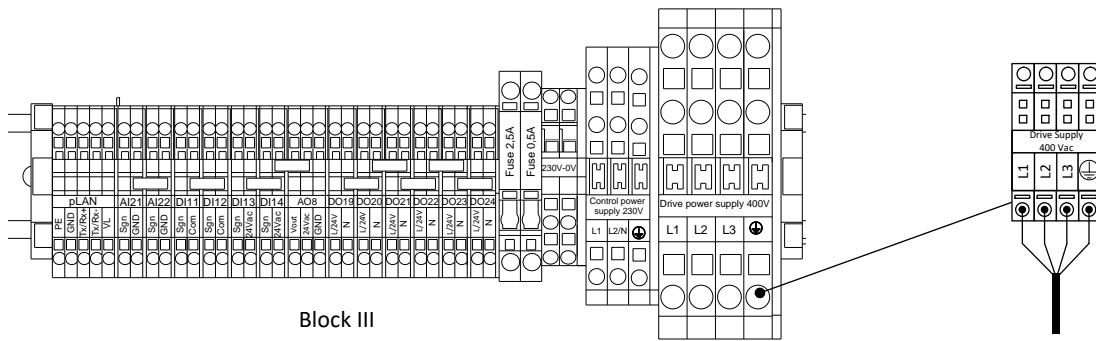

Figure 5.3. Power supply connection scheme of the compressor power supply in three-phase models.

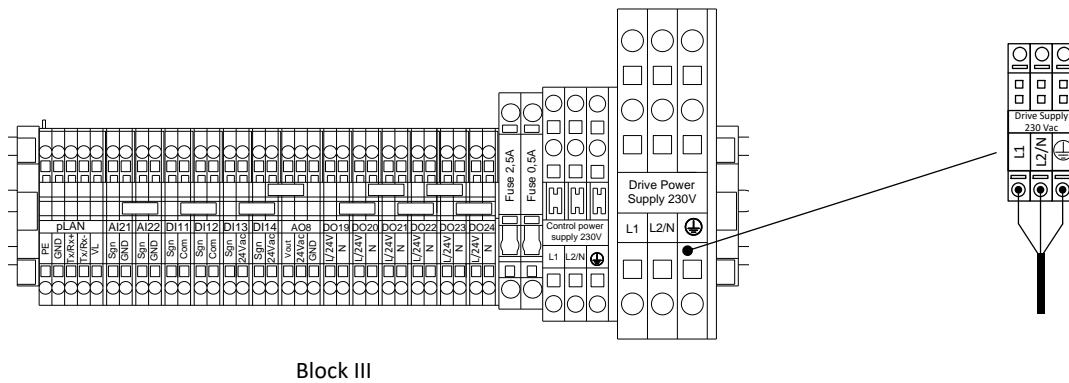

Figure 5.4. Power supply connection scheme of the compressor power supply in single-phase models.

### 5.3. External protections

It is equipped with a connector that can be connected to various types of external mechanical protections, such as flow switches, pressure switches, thermostats, etc.

The ESS connector is used to wire these protections. The external protection devices are powered from the heat pump connector and should have a cut-off capacity of at least 200mA/230Vac.

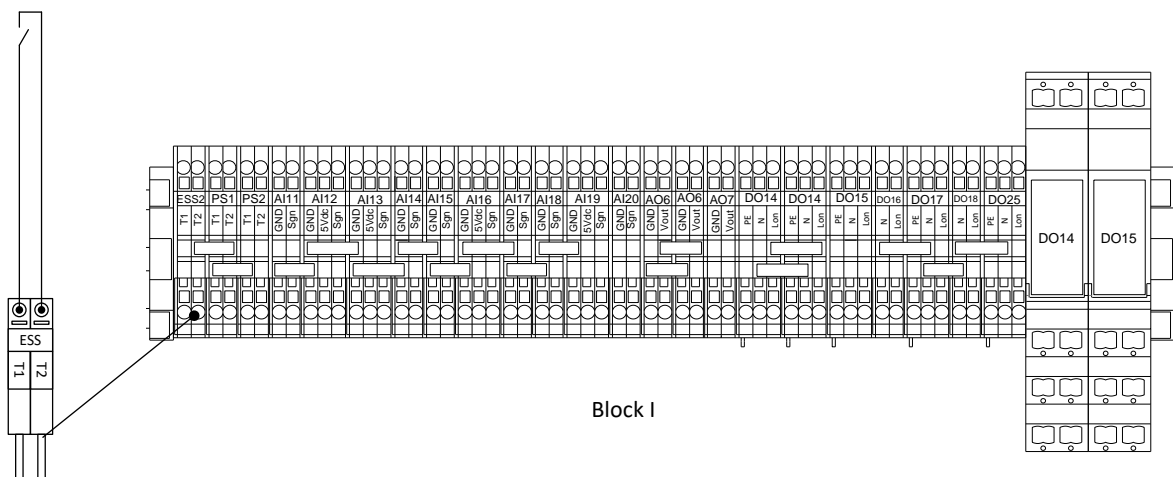

Figure 5.5. Connection scheme of the external protection devices.

## 6. Communication bus between the outdoor and the indoor unit

### 6.1. Communication between outdoor module and Hidrokits and ecoAIR CM

If the ecoAIR+ heat pump is to work, the indoor and the outdoor modules must always communicate via a bus. Install a type AWG20/22 three-pole shielding cable between them. The terminals where they must connect are:

Description	Signal	Indoor unit connector	Outdoor module connector
Indoor - outdoor module communication bus	ModBus RS485	FBus1	BMS2

**Table 6.1.** Connection terminals of the data bus between the indoor units Hidrokits and ecoAIR CM and the outdoor modules.

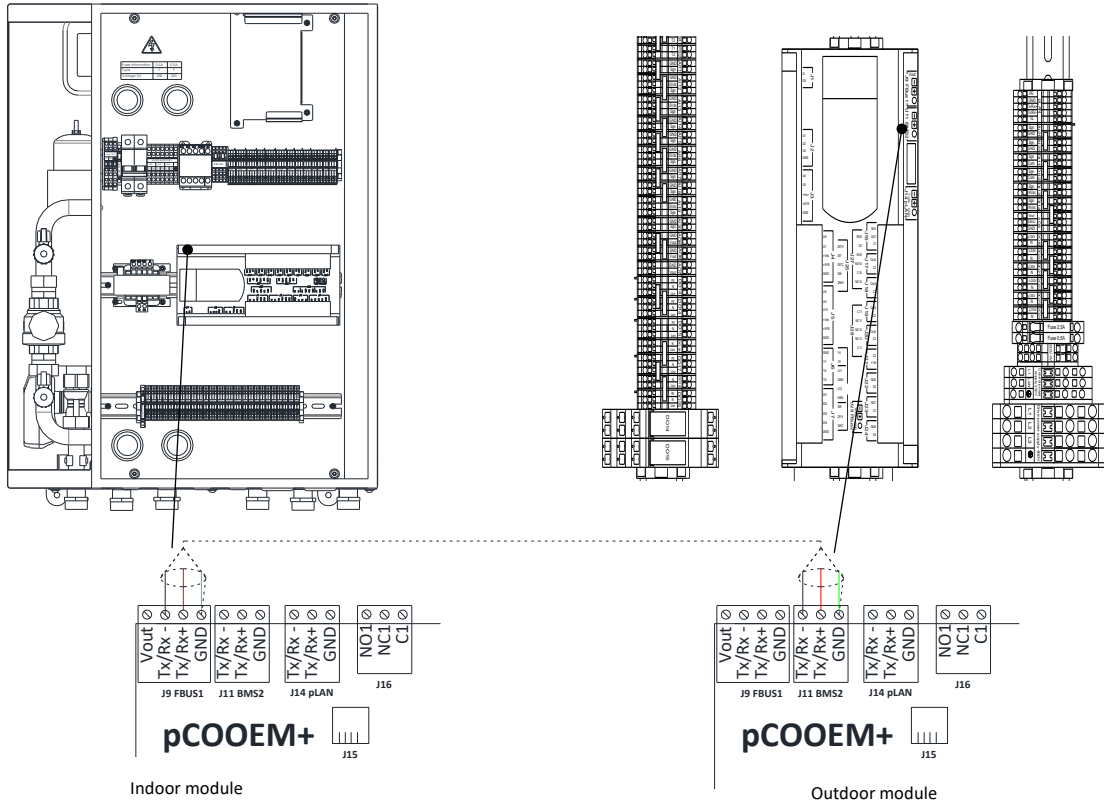

**Figure 6.1.** Connection diagram between the outdoor module and the indoor units Hidrokit and CM

### 6.2. Communication between outdoor module and indoor unit ecoAIR CM Lite

For the ecoAIR+ heat pump to work with the ecoAIR+ CM Lite indoor unit, it is essential that the control display be connected to the outdoor module. Install a type AWG20/22 two shielded twisted pair cable between them. The terminals where they must connect are:

Description	Signal	CM Lite connector	Outdoor module connector
CM Lite - outdoor module communication bus	ModBus RS485	pLAN	pLAN

**Table 6.2.** Connection terminals of the data bus between the indoor unit CM Lite and the outdoor modules.

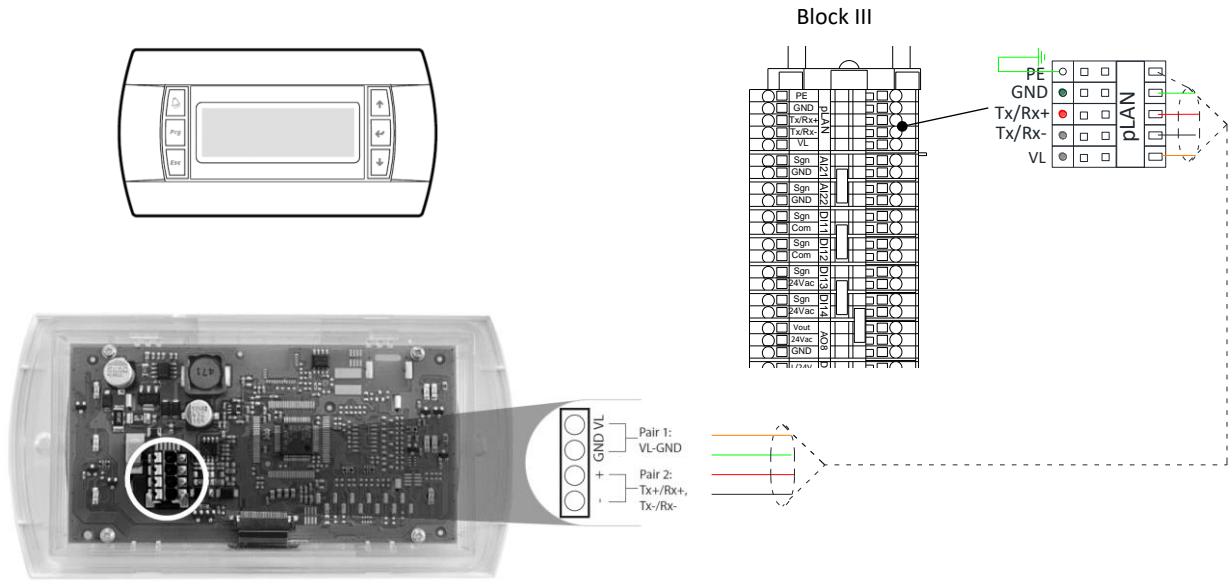

**Figure 6.2.** Connection diagram between the outdoor module and the indoor unit ecoAIR CM Lite.

For more information, consult the manual provided with the screen.

## 7. Technical specifications

The ecoAIR+ outdoor unit contains a fully-integrated refrigeration circuit, pre-loaded with a refrigerant agent and ready to be started up once installed. Therefore, the pipes that connect it to the rest of the installation are hydraulic. Its production circuit also contains a circulator pump and a drain valve.

### 7.1. Component location

No	Description	No	Description
20	Production outlet /indoor unit	37	Suction mini-pressure switch (PRO)
21	Production return /indoor unit	38	Suction pressure transducer
22	Production outlet temp. probe (outdoor unit)	39	Compressor suction temp. sensor
23	Production return temp. probe (outdoor unit)	40	Compressor
24	Production pressure transducer	41	Compressor drain temp. sensor
25	Production circulator pump (outdoor unit)	42	Discharge pressure transducer
26	Automatic drainer	43	Discharge mini-pressure switch
27	Fan	44	Cycle inversion valve
28	Condenser (direct cycle)	45	Defrost elect. heater
29	Evaporator (direct cycle)	46	Drain
30	Filter dryer	47	Electrical panel (outdoor unit)
31	Expansion valve (EVI)	48	Table of electrical connections
32	Expansion valve	49	Power cable inlet (outdoor unit)
33	Liquid tank (PRO) / liquid gas separator (EVI)	50	Control cable inlet (outdoor unit)
34	Intermediate transducer pressure (EVI)	51	Outdoor temp. probe
35	Service outlet	52	Suction accumulator (not in all products)
36	EVI valve (EVI)		

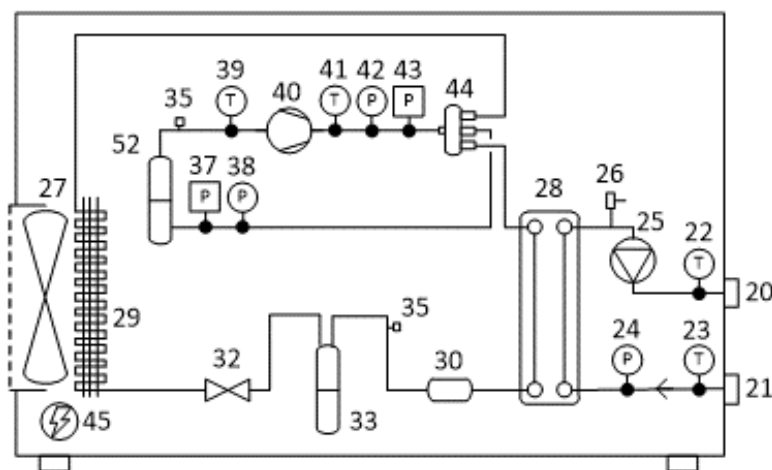

Figure 7.1. ecoAIR+ PRO cooling diagrams.

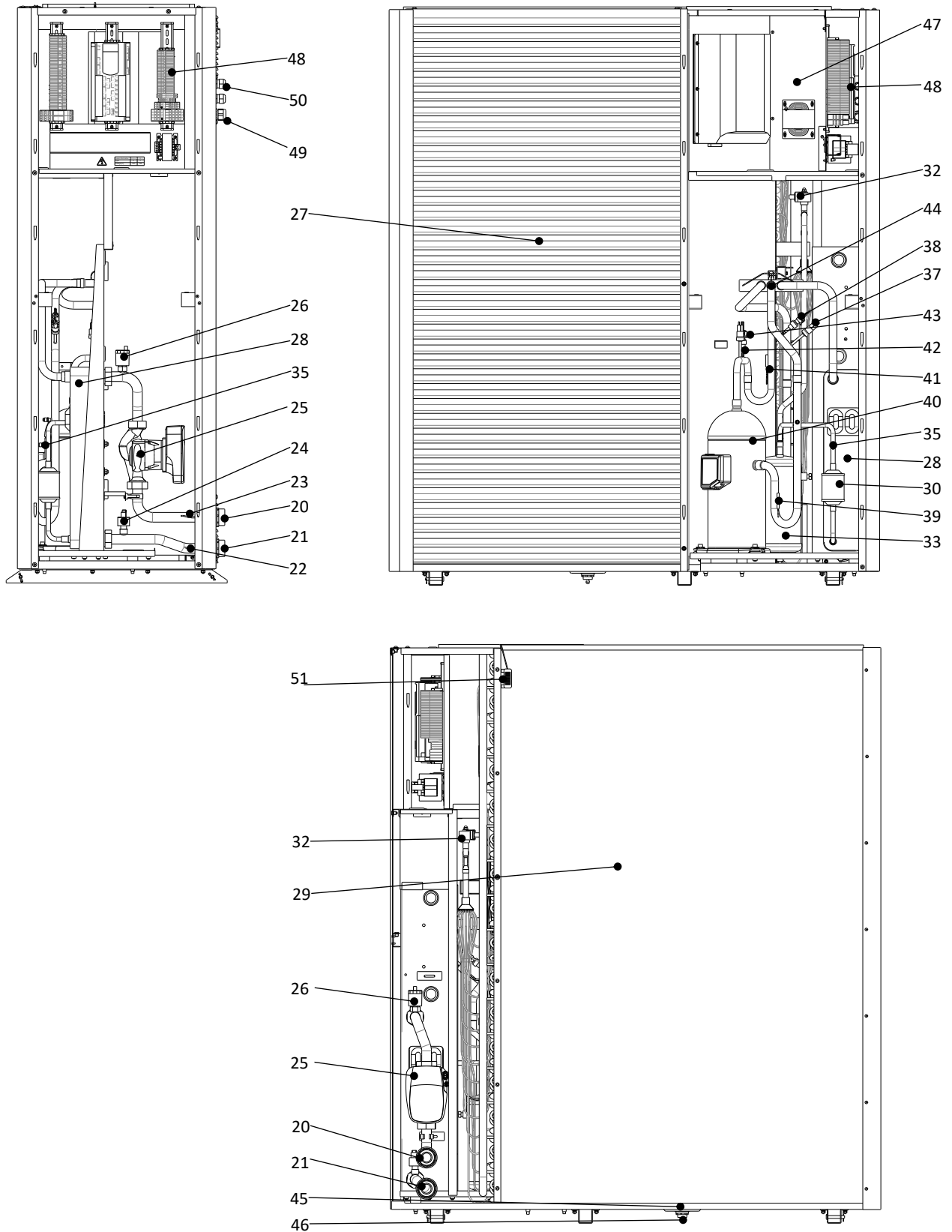

Figure 7.2. Location of components in ecoAIR+ 6-24 PRO module.

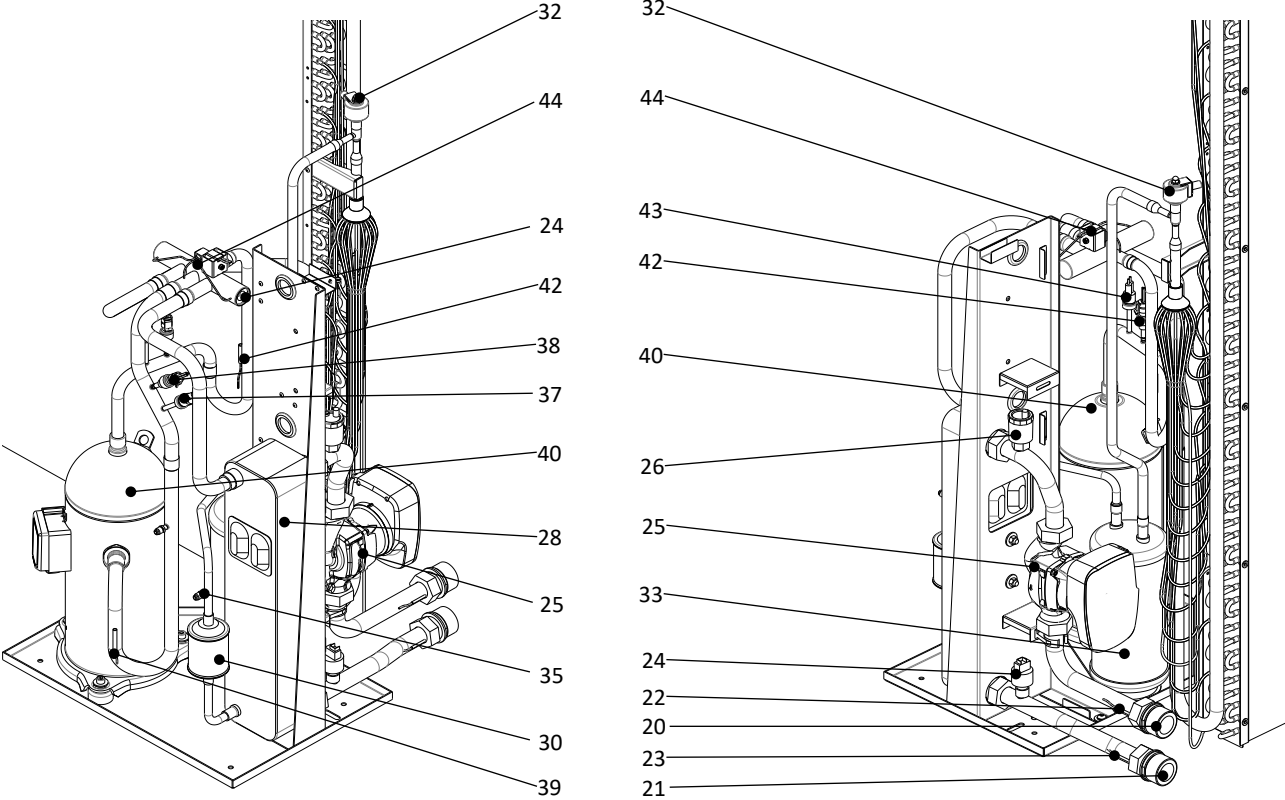
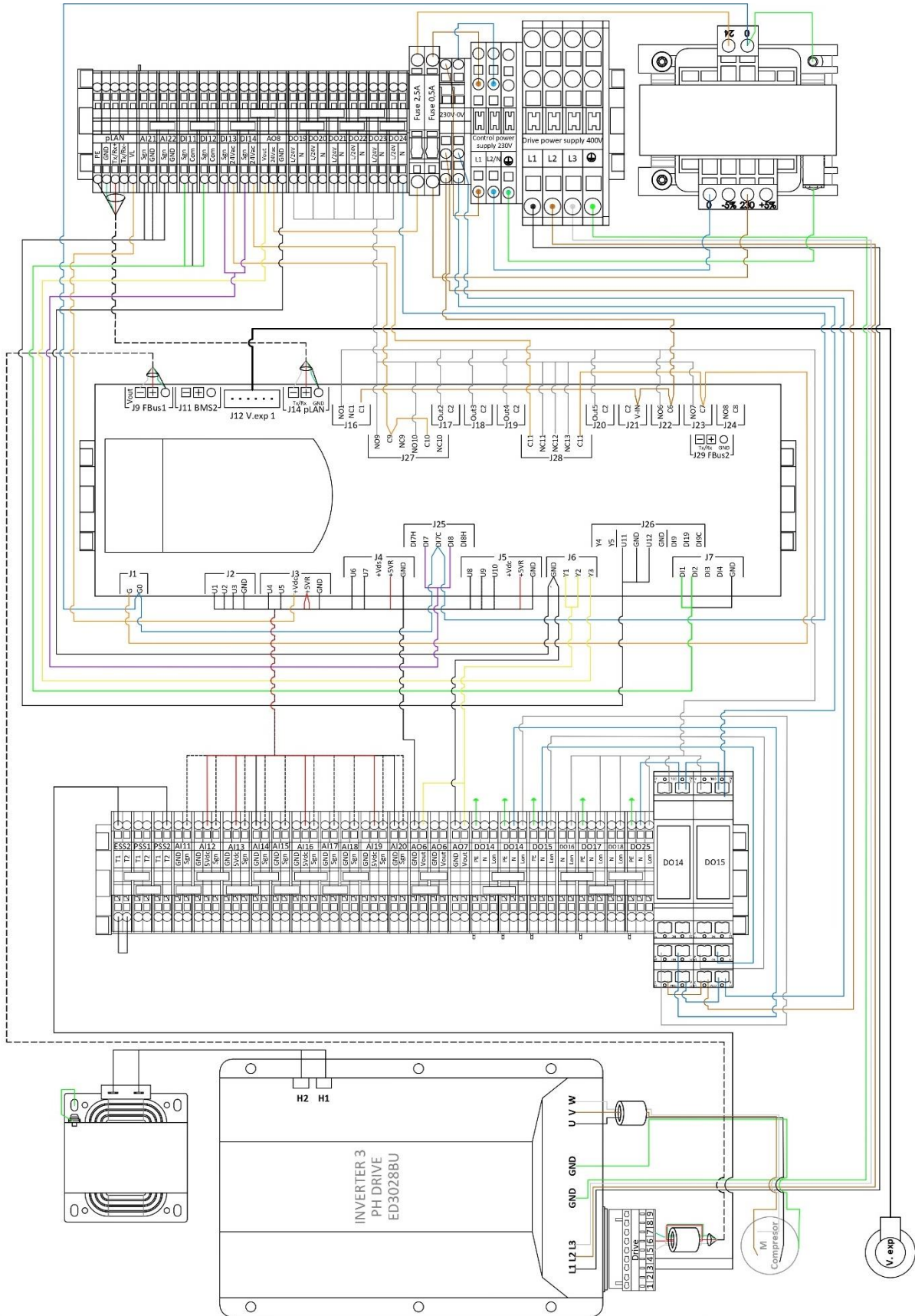

Figure 7.3. Location of components in the ecoAIR+ 6-24 PRO cooling module.

## 7.2. Electrical power diagrams

ecoAIR+ 400 6-24 PRO, three-phase



### 7.3. Electrical connection tables

EN

COMMUNICATIONS			
CONNECTIONS		DESCRIPTION	
Connection terminal	Controller terminal	Type	Signal
Block III / Plan	pCOOEM medium/ J14 pLAN	RS485 ModBus RTU	Display communication
Block II / BMS2	pCOOEM / J11 BMS2	RS485 ModBus RTU	Indoor unit communication
Block II / FBus2	pCOOEM medium/ J29 FBus2	RS485 ModBus RTU	Bus thermostat communication

PROTECTIONS		
CONNECTIONS	DESCRIPTION	
Connection terminal	Type	Signal
Block I / ESS1	Safety switch	External safety switch
Block I / PSS1	Safety switch	High pressure switch
Block I / PSS2	Safety switch	Low pressure switch (PRO)

ANALOG INPUTS			
CONNECTIONS		DESCRIPTION	
Connection terminal	Controller terminal	Type	Signal
Block I / AI11	pCOOEM / J2 / U1	NTC 10K 25 °C	Suction temperature
Block I / AI12	pCOOEM / J2 / U2	Radiometer 0-5Vdc	Suction pressure
Block I / AI13	pCOOEM / J2 / U3	Radiometer 0-5Vdc	Discharge pressure
Block I / AI14	pCOOEM / J3 / U4	NTC 50K 25 °C	Discharge temperature
Block I / AI15	pCOOEM / J3 / U5	NTC 10K 25 °C	Reserved temperature
Block I / AI16	pCOOEM / J4 / U6	Radiometer 0-5Vdc	Intermediate pressure (EVI)
Block I / AI17	pCOOEM / J4 / U7	NTC 10K 25 °C	Production outlet temperature
Block I / AI18	pCOOEM / J5 / U8	NTC 10K 25 °C	Production inlet temperature
Block I / AI19	pCOOEM / J5 / U9	Radiometer 0-5Vdc	Production pressure
Block I / AI20	pCOOEM / J5 / U10	NTC 10K 25 °C	Outside temperature
Block III / AI21	pCOOEM medium / J26 / U11	NTC 10K 25°C	DHW temperature
Block III / AI22	pCOOEM medium / J26 / U12	NTC 10K 25°C	Heating/Cooling buffer tank / modulating heater temperature (Optional)

ANALOG OUTPUTS			
CONNECTIONS		DESCRIPTION	
Connection terminal	Controller terminal	Type	Signal
Block I / AO6	pCOOEM / J6 / Y1	0-10Vdc	Regulation Fan
Block I / AO7	pCOOEM / J6 / Y2	PWM	Production circulator regulation
Block III / AO8	pCOOEM / J6 / Y3	0-10Vdc	Heat Aux. Generator regulation

DIGITAL INPUTS			
CONNECTIONS		DESCRIPTION	
Connection terminal	Controller terminal	Type	Signal
Block III / DI11	pCOOEM medium / J7 / DI1	Voltage-free (0V)	Direct group DG1 heating demand
Block III / DI12	pCOOEM medium / J7 / DI2	Voltage-free (0V)	Direct group DG1 cooling demand
Block III / DI13	pCOOEM medium / J25 / DI7	24 Vac signal	Control of electrical consumption (EVU, SG, FNN)
Block III / DI14	pCOOEM medium / J25 / DI8	24 Vac signal	



DIGITAL OUTPUTS			
CONNECTIONS		DESCRIPTION	
Connection terminal	Controller terminal	Type	Signal
Block I / DO14	pCOOEM / J16 / NO1	Activation 230Vac / 1A max.	Fan
Block I / DO15	pCOOEM / J17 / Out2	Activation 230Vac / 1A max.	Production circulator pump
Block I / DO16	pCOOEM / J18 / Out3	Activation 230Vac / 2A max.	Active cooling production
Block I / DO17	pCOOEM / J19 / Out4	Activation 230Vac / 2A max.	EVI activation (EVI)
Block I / DO18	pCOOEM / J20 / Out5	Activation 230Vac / 2A max.	Defrost elect. heater
Block III / DO19	pCOOEM medium / J28 / NO11	Activation 24Vac / 2A max.	DHW production activation
Block III / DO20	pCOOEM medium / J28 / NO12	Activation 24Vac / 2A max.	DHW auxiliary heater activation
Block III / DO21	pCOOEM medium / J28 / NO13	Activation 24Vac / 2A max.	Production direct group DG1
Block III / DO22	pCOOEM medium / J27 / NO9	Activation 24Vac / 2A max.	Alarm signal
Block III / DO23	pCOOEM medium / J27 / NO10	Activation 24Vac / 2A max.	Cooling / heating production /consumption (Optional)
Block III / DO24	pCOOEM medium / J23 / NO7	Activation 24Vac / 2A max.	Outlet / Buffer auxiliary heater activation (Optional)
Block I / DO25	pCOOEM medium / J22 / NO6	Activation 230Vac / 2A max.	HTR

### 7.4. Hydraulic operational area

ecoAIR+ 400 6-24 PRO

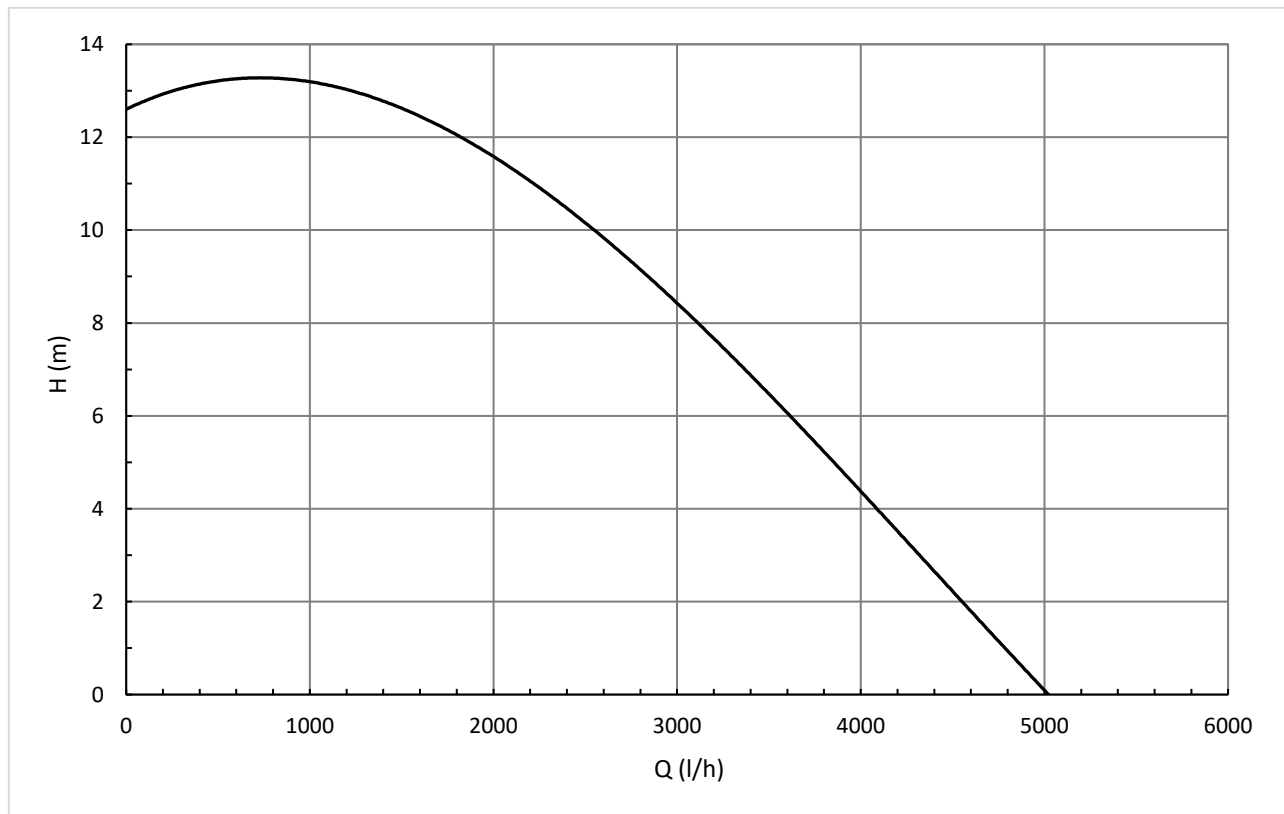

## 8. Operation map

ecoAIR+ 400 6-24 PRO

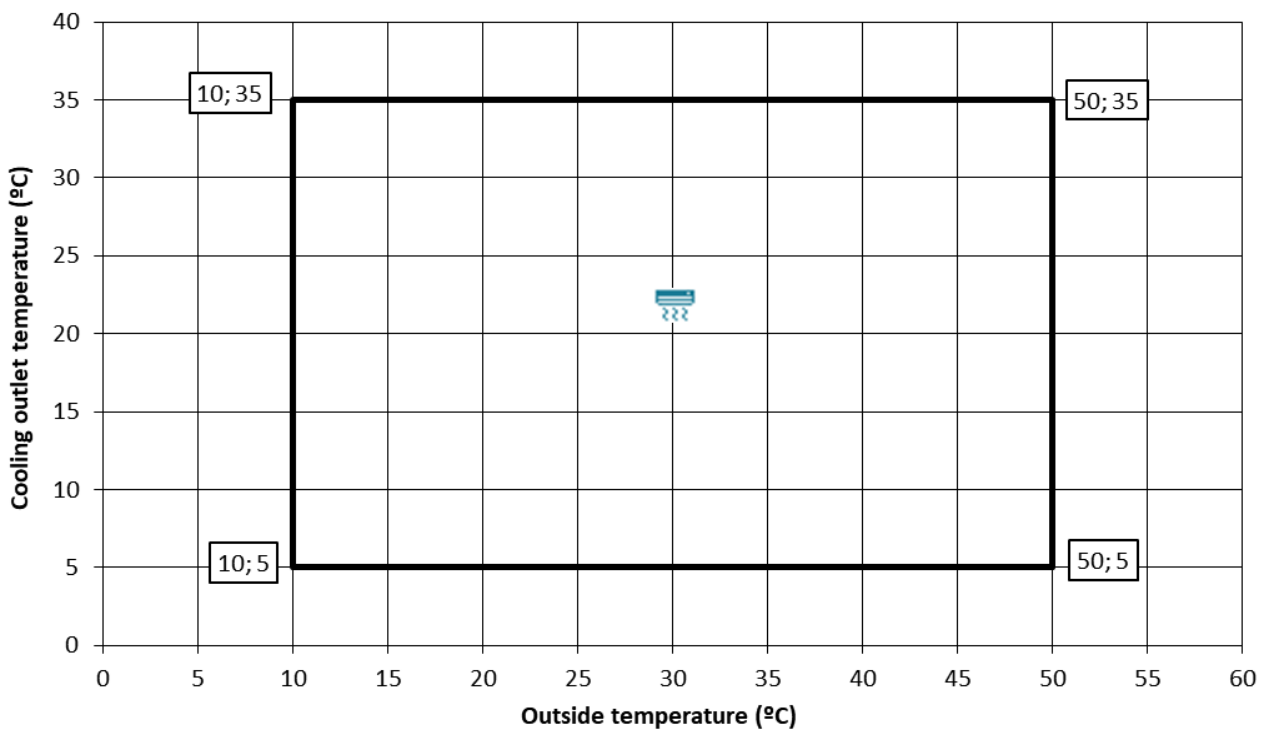
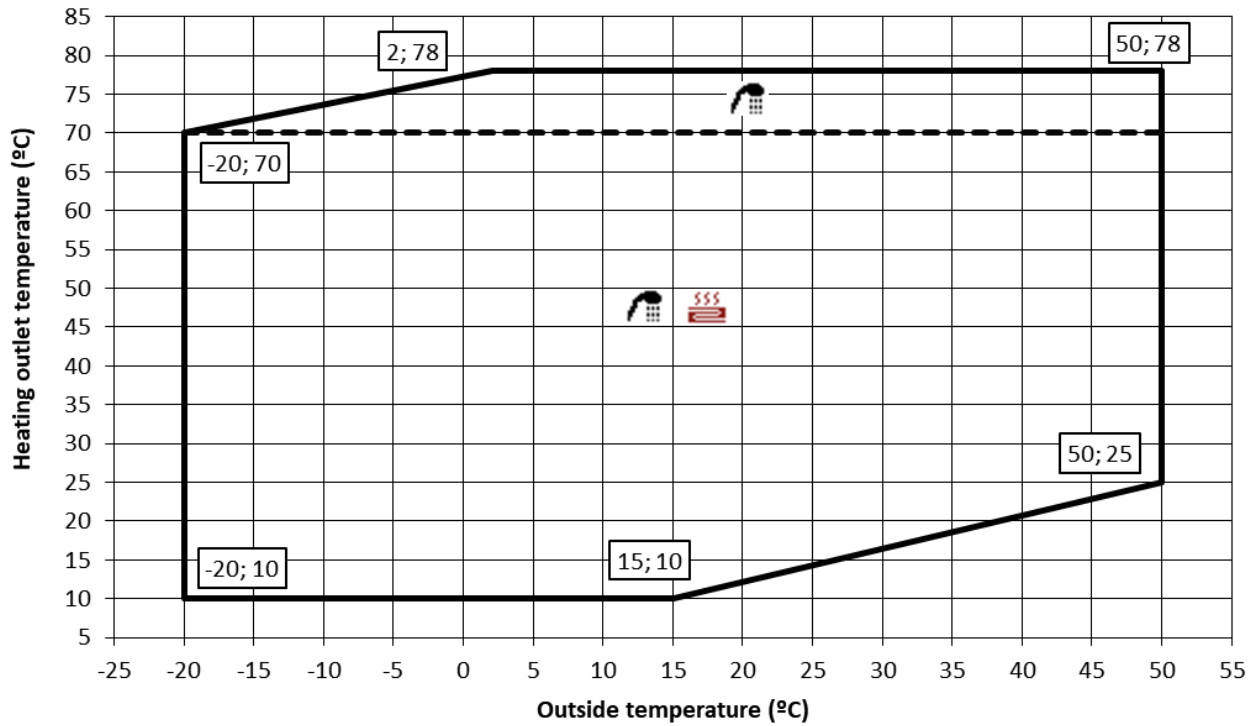

### 9. Operation curves

ecoAIR+ 400 6-24 PRO

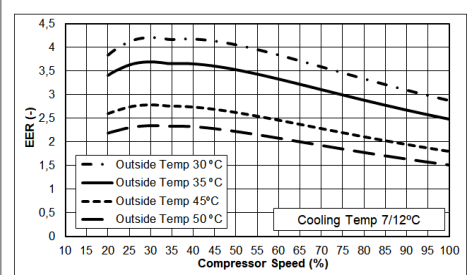
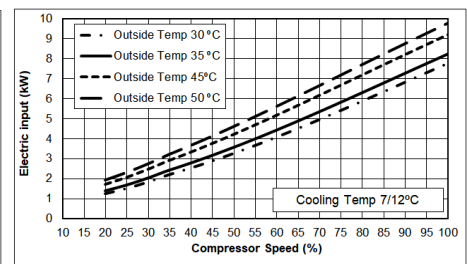
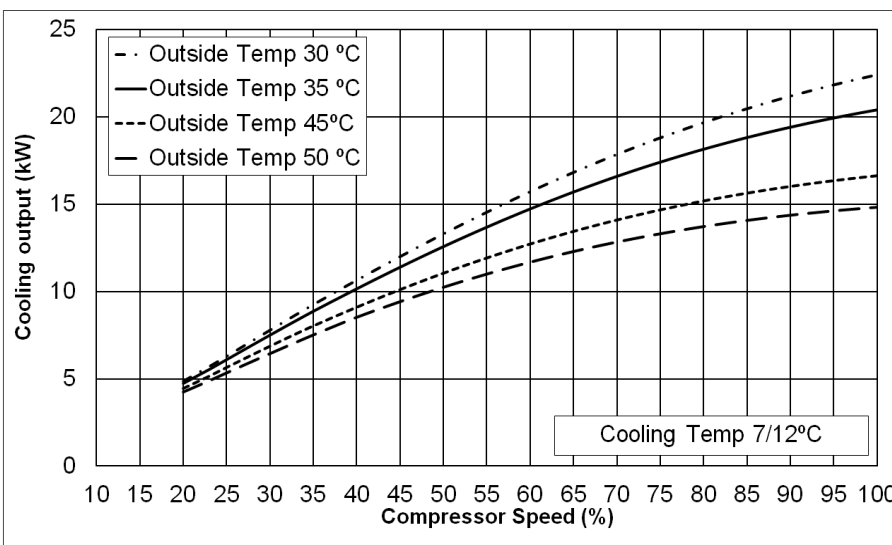
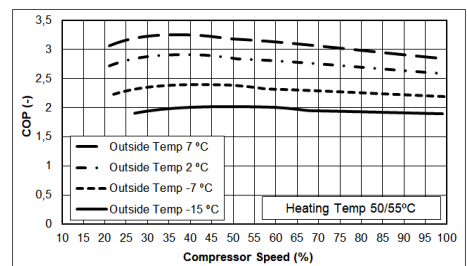
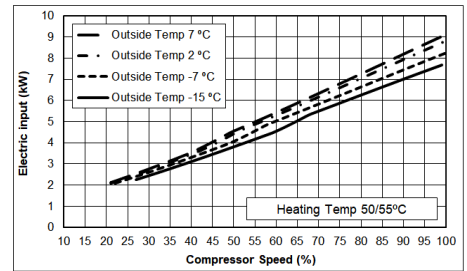
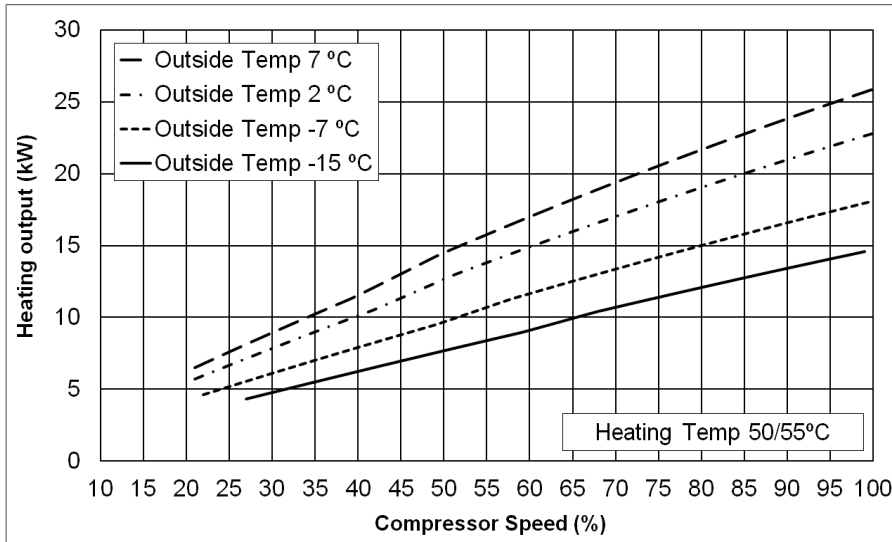
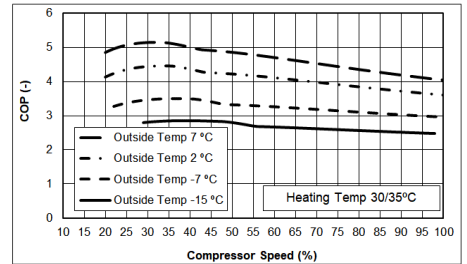
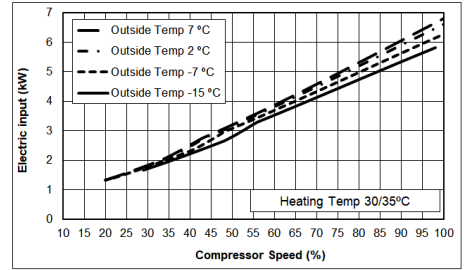
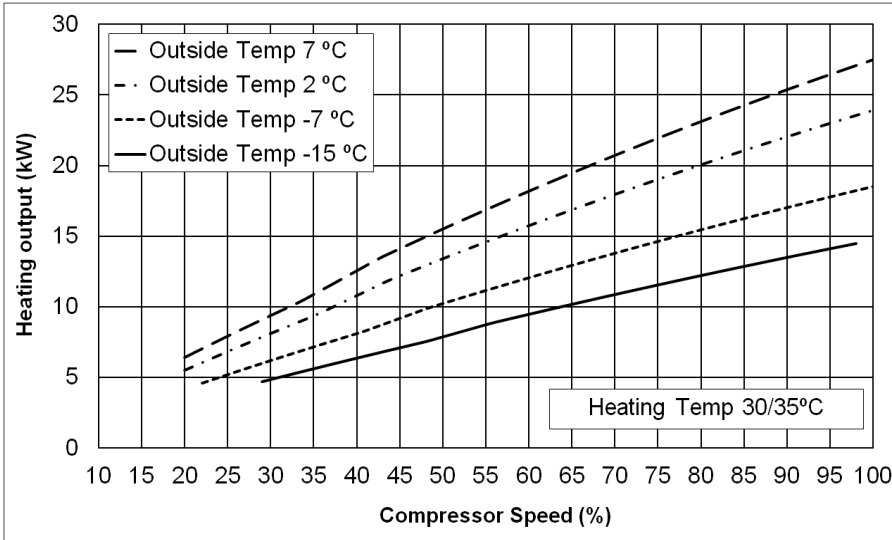

## 10. Technical data table















### NOTE

- In the technical data tables, you will find a series of numbers in superscript format, the meaning of which is explained below:
  1. In compliance with EN 14511, this includes the consumption of the circulation pumps and the compressor driver. Production thermal gap ( $\Delta T = 5 \text{ }^\circ\text{C}$ ).
  2. In compliance with EN 12102, this includes the acoustic insulation kit of the compressor.
  3. The permitted voltage range for correct operation of the modules is  $\pm 10\%$ .
  4. Maximum consumption can vary significantly according to working conditions, or if the compressor's range of operation is restricted.
  5. Only for installations with Hidrokit Compact.
  6. Refer to the certification.
  7. Considering support provided by the back-up or emergency electrical resistor.
  8. Start-up intensity depends on the operating conditions of the hydraulic circuits.
  9. The installation must be carried out in such a way as to guarantee the nominal flow rates, which will be calculated for the maximum powers with a temperature differential of  $5^\circ\text{C}$ . On the other hand, to ensure correct compressor start-up, the installation must guarantee a flow rate greater than that resulting from the formula:  
$$Q \geq 1.2 \times P_{ref}$$
 where:
    - $Q$  = flow in litres per minute.
    - $P_{ref}$  = cooling power at 25% of compressor. Refer to the module's operation curves.
  10. In compliance with IEC 60529 (IEC 60335-2-40:2018)

OUTDOOR UNIT Specifications		modules	ecoAIR+ 6-24 PRO
Application	Place of installation	-	Exterior
	Type of brine system	-	Aerothermal
Protection	Protection level <sup>10</sup>	-	IP24
Performance	Compressor range of modulation	%	22 – 100
	Heating power, A7W35 <sup>1/6/9</sup>	kW	4.8 – 27.5
	Max. COP / Heating power, A7W35 <sup>1/6/9</sup>	- / kW	5.1 / 10
	Heating power, A7W55 <sup>1/6/9</sup>	kW	6.5 – 25.9
	Max. COP / Heating power, A7W55 <sup>1/6/9</sup>	- / kW	3.2 / 11
	Cooling power, A35W7	kW	4.7 – 20.5
	Max. EER / Cooling Power A35W7	- / kW	3.6 / 9.5
	Maximum DHW temperature without backup <sup>5</sup>	°C	78
	Maximum DHW temperature with back-up <sup>5/7</sup>	°C	80
	Noise emission level <sup>2/4/6</sup>	db	63
	Energy Label / $\eta_s$ average temperature with control <sup>4/6</sup>	-	A+++ / 184%
Operation limits	Heating temperatures	°C	10 – 78
	Cooling temperatures	°C	7–35°C)
	Outside temperature	°C	-20 – 50
	Min/max refrigerant circuit pressure	bar	0.5 – 25.5
	Production circuit pressure	bar	0.5 – 6
Working fluids	Type / GWP	--	R290 / 3
	Refrigerant load/ T CO <sub>2</sub> equivalent	Kg/Ton	1.75 / 0
	Compressor oil type / load	L	RFL68 EP / 1.18
Electrical control data	1/N/PE 230Vac / 50-60 Hz <sup>3</sup>	-	✓
	Maximum recommended external protection	A	C5A
	Primary transformer circuit fuse	A	0.5
	Secondary transformer circuit fuse	A	2.5
Heat pump electrical data three-phase	3/PE 400Vac / 50-60 Hz <sup>3</sup>	--	✓
	Maximum recommended external protection <sup>4</sup>	A	C32A
	Maximum consumption <sup>1</sup> , A7W35	kW/A	6.81 / 9.9
	Maximum consumption <sup>1</sup> , A7W55	kW/A	9.12 / 13.2
	Min/max starting current <sup>8</sup>	A	3 / 12
	Correction of cosine $\phi$	--	0.80 - 1
Dimensions and weight	Height x width x depth	mm	1675x1430x640
	Empty weight (without assembly)	kg	266

## 11. Symbols

	Heating system		Cut-off valve
	Cooling system		Safety valve
	NTC temperature sensor		Particulate filter
	Open/closed contact or thermostat signal		Outlet pipe
	Data bus communication terminal		Return pipe
	Drain defrosts heater		Flexible hose
	Expansion vessel		



ECOFOREST GEOTERMIA, S.L.

Parque Empresarial Porto do Molle, Rua das Pontes, 25

36350 Nigrán - Pontevedra (Spain)

Tel.: +34 986 262 184 / +34 986 417 700

Fax: +34 986 262 186

e-mail: [Info@ecoforest.es](mailto:Info@ecoforest.es)

<http://www.ecoforest.es>



**ecoforest**  
biomasa - bomba de calor - solar

The manufacturer reserves the right to make modifications without prior notice.