

süd  wind



Decentralised home ventilation
system with heat recovery.

ambientika[®]

Guaranteed quality

The air we breathe indoors is full of pollutants and contaminants that can threaten our health and cause respiratory illness. Chipboard contained in furniture, paints or coatings that can emit toxic substances, as well as smoke particles and carbon dioxide are the main causes. Moisture, mainly caused by the presence of humans, causes mould and damages the fabric of buildings.

To ensure a healthy living environment mechanical ventilation systems are recommended. Advanced systems help achieve savings with a heat exchanger for heat recovery from the exhaust air and through an elaborate system for insulation and sealing the building envelope.

Our Ambientika ventilation system with integrated heat recovery heats the externally supplied fresh air with the waste heat from the used air in the room in the wintertime. In the summertime, when temperatures indoors are lower, the heat exchanger cools the fresh air supplied from the outside. This not only ensures a healthier living environment, but also saves on energy.

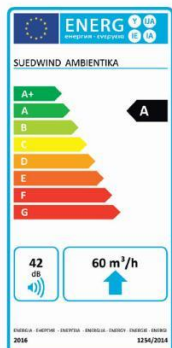

Ambientika eco

Our decentralised ventilation unit with integrated alternating flow direction and ceramic heat exchanger is supplied with a Ø 160 / 100 mm installation pipe and is very low in energy consumption. The unit is ideal for ventilating single rooms such as living rooms or bedrooms. For balanced ventilation, the unit should always be used in pairs with synchronous control. The system represents the perfect solution for maintaining a healthy indoor climate and removing CO₂, impurities and moisture from the air that are capable of adversely affecting the health of the occupants and impairing the building fabric.



Our **GHOST** is an energy-saving, decentralized ventilation unit with integrated heat exchanger that transports stale, contaminated air outside and exchanges it for fresh air. The thermal energy in the exhaust air is used to warm the fresh air from the outside.



The unit is equipped with a highly efficient, low noise EC motor (brushless) and is based on the concept of reducing energy consumption through „heat recovery“ for heating and air conditioning buildings.



The ceramic heat exchanger has a thermal efficiency of up to **93%** and ensures the best results when it comes to saving energy.



The unit is equipped with integrated sensors. In AUTO mode, the units regulate themselves, so no further intervention by the user is required.

Products in comparison

Our **GHOST** decentralized home ventilation system with integrated heat recovery clearly stands out from comparable products. Why? Simply because it combines innovative technology with exceptionally simple and intuitive operation. Our decentralized home ventilation systems with integrated heat recovery are also very easy to install and are currently among the best and most versatile on the market.

They can also lower the radon levels if properly installed. **GHOST** home ventilation systems are also ideal for converted, renovated and refurbished properties, since they are also easy to retrofit without a great deal of effort. The filter can be cleaned in seconds without the need for any tools.



GHOST eco

Our ECO model operates autonomously and requires no manual control; suitable for single room solutions.

- ✓ Includes a set of G3 filters
- ✓ Compact, versatile, and user-friendly
- ✓ Minimal noise emissions
- ✓ Made with high-quality materials
- ✓ Automatic operation makes it ideal for rental properties
- ✓ Energy-efficient



GHOST advanced+ 100 mm

The device is suitable for bathrooms/toilets with floor area up to 15m². Using the timer setting, the device operates for 20 minutes at full load, and then switches back automatically to the previously set mode.

- ✓ Automatic operation
- ✓ Unit supplied with remote control and wall mounting bracket
- ✓ Minimal noise emissions – high-tech fan
- ✓ Optional free cooling
- ✓ Bathroom ventilator



GHOST solo+

The SOLO model, suitable for single-room solutions, operates autonomously without requiring manual control.

- ✓ Includes a set of G3 filters
- ✓ Compact, versatile, and user-friendly
- ✓ Minimal noise emissions - high-tech fan positioned behind the heat exchanger
- ✓ Made with high-quality materials
- ✓ Automatic operation makes it ideal for rental properties



Bestseller

GHOST advanced+

With integrated sensor technology

- ✓ Automatic operation
- ✓ Unit supplied with remote control and wall mounting bracket
- ✓ Can be wired to up to 15 other devices
- ✓ Minimal noise emissions – high-tech fan positioned behind the heat exchanger
- ✓ Also suitable for **single room solutions**
- ✓ Optional free cooling



GHOST wireless+ !!!

With integrated sensor technology

- ✓ Automatic operation
- ✓ Unit supplied with remote control and wall mounting bracket
- ✓ Can be wirelessly connected to up to 15 other devices
- ✓ Minimal noise emissions – high-tech fan positioned behind the heat exchanger
- ✓ Safe and reliable radio frequency (with built-in transmitter/receiver)
- ✓ Optional free cooling

Optional accessories



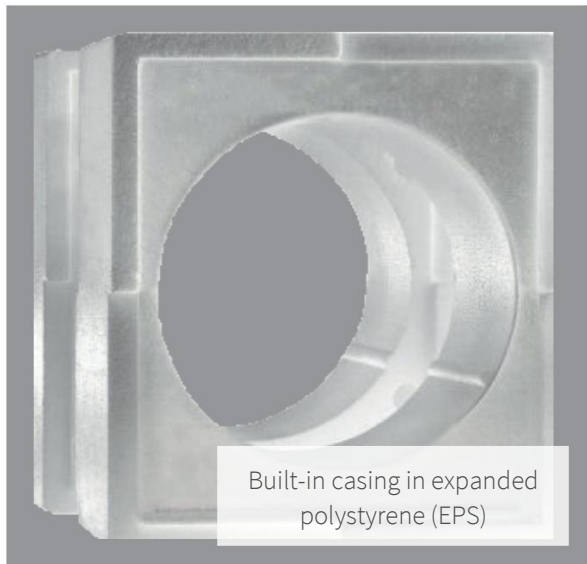
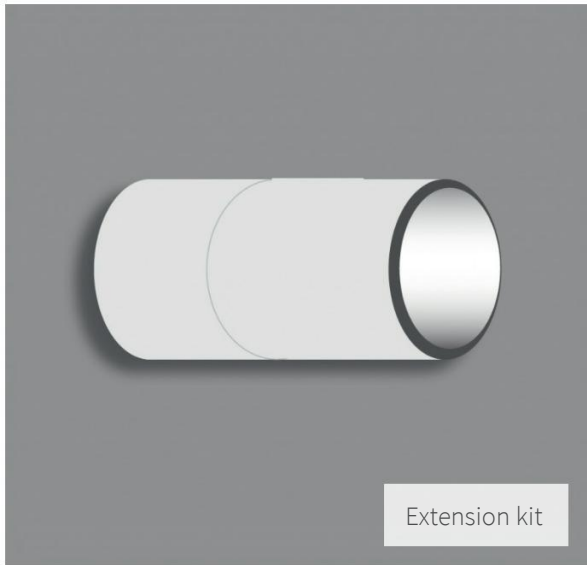

Additional Information about accessories can be found on our website at www.termika.md



Remote Control



AUTOMATIC MODE

Senzorul de umiditate și senzorul de **zi-noapte** sunt ambele active. Prin urmare, unitățile funcționează automat fără a fi nevoie să primească comenzi suplimentare.

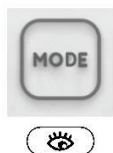

MOD DE MONITORIZARE

Unitățile sunt în mod standard, cu clapeta închisă și senzorii activi. Ca urmare va intra în modul de evacuare atunci când umiditatea depășește pragul setat.



MODUL MANUAL

Senzorii sunt dezactivați iar unitatea activează continuu în modul de recuperare a căldurii. Utilizatorul poate decide la ce viteză ar trebui să funcționeze unitatea de ventilare; aceasta setare este păstrată până când nu este setat manual o altă comandă.

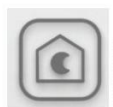

MODUL DE NOAPTE

Modul de setare - noapte, toate unitățile de recuperare a căldurii funcționează la viteza cea mai redusă astfel asigurând liniștea și confortul în timpul somnului.

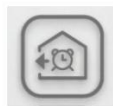

MODUL DE EXTRAGERE-20min

Dacă apăsați acest buton, toate unitățile intră în modul de extragere timp de 20 de minute la viteza maximă, ca după să revină la modul setat anterior.

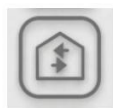

MOD AERISIRE MASTER-SATELIT

În acest mod, unitățile generează un flux continuu de aer care duce de la unitățile configurate cum ar fi de la MASTER către SATELIT sau invers SATELIT către MASTER fără recuperarea căldurii.

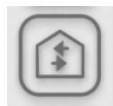

MOD AERISIRE SATELIT MASTER

În acest mod unitățile generează un flux continuu de aer care duce de la unitățile configurate cum ar fi SATELIT către MASTER sau viceversa fără recuperarea căldurii.

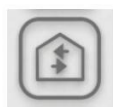

MODUL DE EXTRAGERE SI APROVEZIONARE CU AER

Vezi descrierea mai sus.

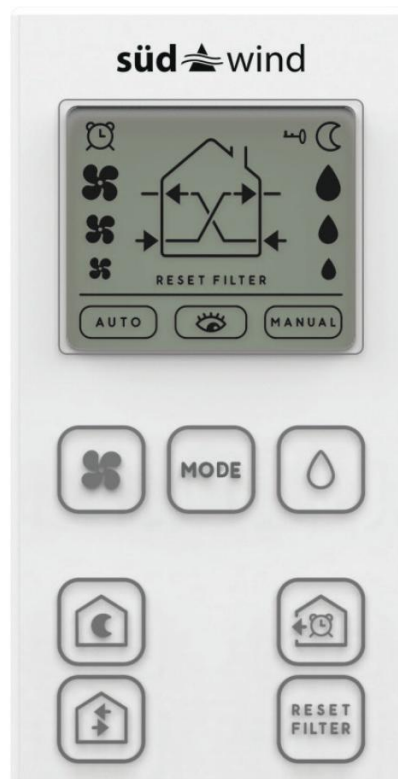



Optional: Panou de Perete cu sensor de CO2

Beneficiile Recuperatorului



Usor de instalat

Installing the ventilation system is child's play. The electronics are installed inside the unit. The average time required for assembly approx. 1 hour. Thanks to integrated sensors the units control themselves automatically following installation.



Extrem de usor de curatat

Removing just a few components makes cleaning almost child's play: with the exception of the electronic unit, simply washing out the filters and washing off the plastic parts (impeller, grille, etc.) suffices to service the unit periodically. An LED light indicates when servicing is required.



Connectarea unitatilor prin wireless +

The units can be connected by cable or wirelessly. This also provides for beneficial ventilation functions such as FREECOOLING in the summer.



Descrierea recuperatorului

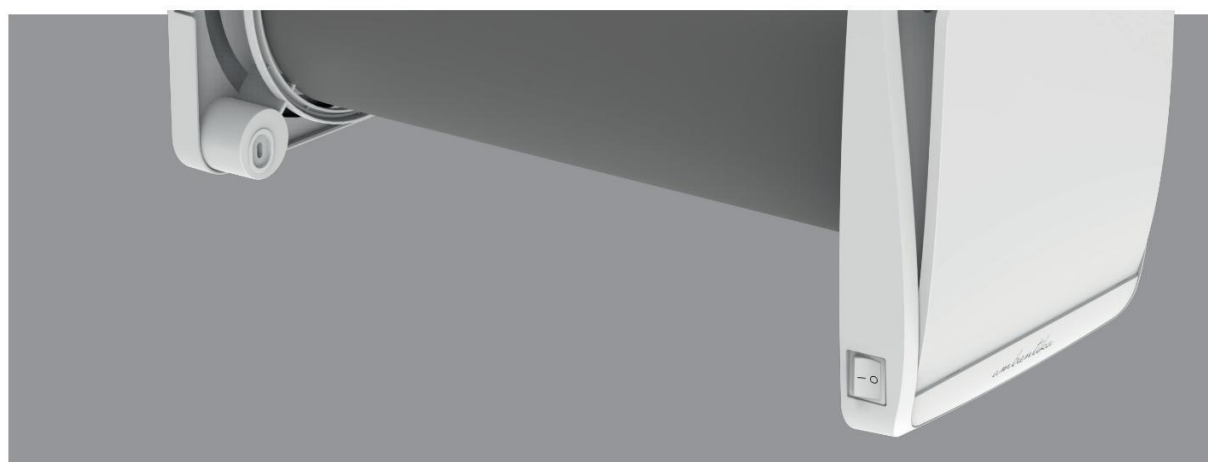
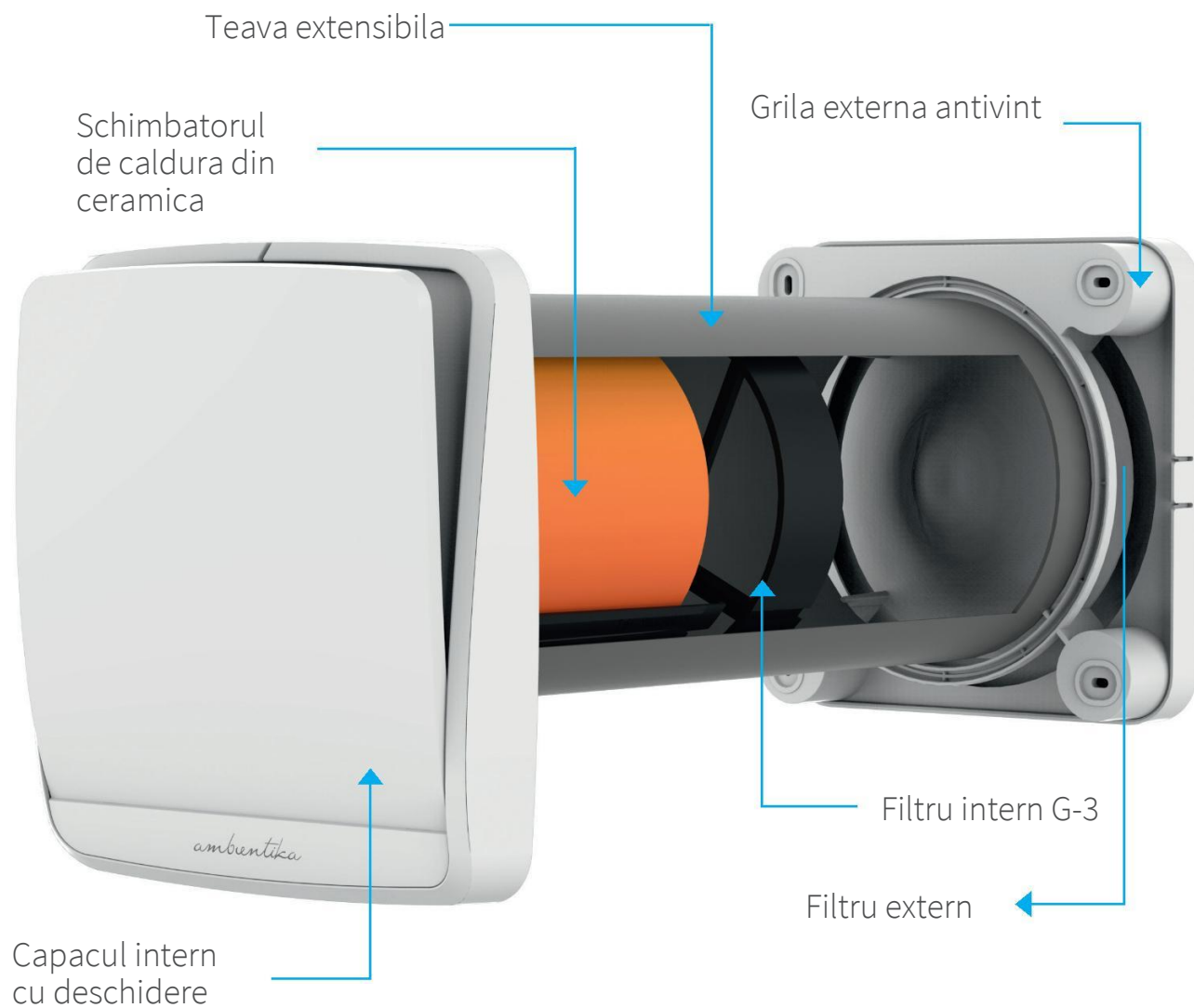

Pornire/oprire manuala

The importance of a healthy living space

Questions & Answers

Are our homes really full of contaminants and pollutants?

Yes indeed, although they are mostly invisible and odourless, exist dissolved in the air that we breathe in our homes and can attack the respiratory tract. They originate from paints and varnishes on walls and furniture, from smog and CO2 emissions, and from smoke and dust. Our decentralised home ventilation system lowers the concentration of radon in the air.

Does domestic ventilation impact upon on the energy consumption and efficiency of low-energy homes?

Not with Ambientika, the decentralised ventilation system with integrated heat recovery. A solid ceramic heat exchanger prevents the loss of heat during air exchange. The impact on the temperature – whether cold or warm – remains as small as possible.

A healthy living environment is also a quiet living environment, but what about a home ventilation system?

Thanks to its movable flaps, Ambientika is designed to isolate the exterior and interior. The flaps close and only open again when the air flow needs to be guaranteed. Their extremely quiet operation also guarantees peace and quiet, which makes our decentralised home ventilation systems incomparable.

Do home ventilation systems with an appealing design exist?

Our Ambientika decentralised home ventilation system is covered on the outside and the inside with a white cover. This means that the ventilation system is integrated discretely into the room's surroundings and its inner workings are hidden in a very discreet and elegant way.

How do I go about maintaining and cleaning the unit?

The air filter on the decentralised home ventilation unit should be cleaned every three months and replaced every two years. Replacing or cleaning the filter can be carried out in next to no time without the need for a separate tool.

Design Unical

Maximum functionality in minimalist design – our GHOST decentralized home ventilation system fits elegantly and inconspicuously into the look of every home. The white ABS panels in an attractive design round off the high-quality materials and perfect workmanship of the unit perfectly.



1

FRONT VIEW

The DESIGN panel is attached to the wall in the living room.

2

COVER

Monocoque cover made of glossy white ABS in minimalist design.

3

FAN UNIT

Glossy white ABS in compact design.



PIPE

In PVC with a 160 mm diameter.



EXTERNAL GRILLE

Designed to protect against wind and noise from the outside.



SPATELE

The rear (paintable) is attached to the exterior wall of your home. UV-resistant.

Unit Properties

- ✓ ADVANCED + WIRELESS model: Including remote control or optional wall panel
- ✓ Compact, versatile and easy to use, with automatic programs for simplified use and ideal home comfort.
- ✓ No run-off needed for condensate
- ✓ ADVANCED + WIRELESS model: Free cooling operation possible in the summertime with at least 2 units
- ✓ Quiet operation
- ✓ Highly efficient, maintenance-free, EC motor
- ✓ For installation in external walls with 250 to 500 mm wall sleeves. Optional: Pipe extension
- ✓ Quick and easy access to the filter and heat exchanger
- ✓ Automatically closing flap mechanism
- ✓ Ceramic heat exchanger with up to 93% efficiency. Thermally insulated.
- ✓ Dual filters: one for fresh air and one for air extraction, easy to remove and clean. With optional pollen filter for allergy sufferers.
- ✓ Adjustable air volume of up to 60 m³/h
- ✓ Pressure capacity for distances of up to 3 m over smooth Ø 160 mm pipes. Up to 2.5 m with a 90° bend
- ✓ Minimal energy consumption
- ✓ No ventilation ducts required
- ✓ Exchange against existing wall fans without interfering with the building envelope
- ✓ ADVANCED + WIRELESS model: Integrated sensors monitor the function and control the units independently if desired (air humidity, light sensor or optionally CO₂)

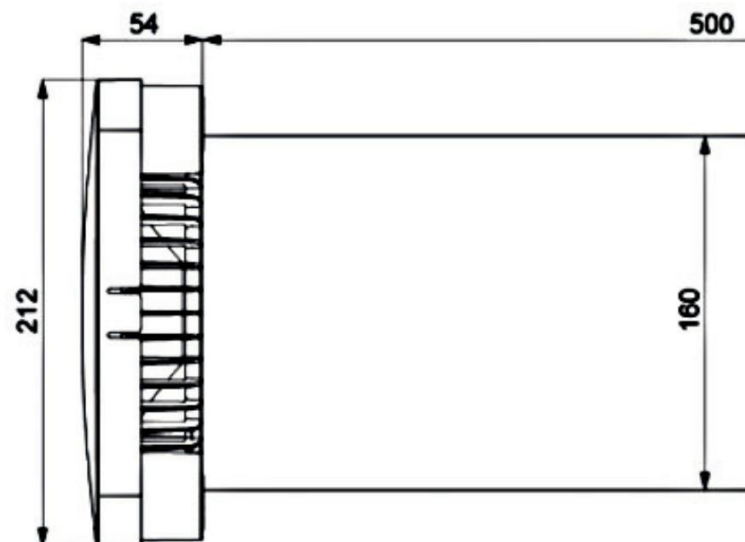
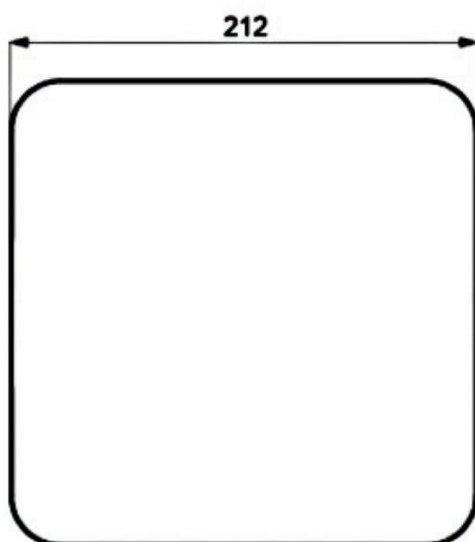

PARAMETERS	UNIT OF MEASUREMENT	VALUES
Air flow at maximum speed	m ³ /h	60
Ceramic heat recovery efficiency	%	93
Noise level at maximum speed (at 3m)	dB(A)	24
Noise level at min. speed (at 3m)	dB(A)	20
Operating temperature	°C	-20°C +50°C
Power	W	3,9 - 6,7
Filter	N°	2
Filter class: EN 779	-	G3
Power supply	V/Hz	230 Vac – 50 Hz
Protection Class	-	IP44

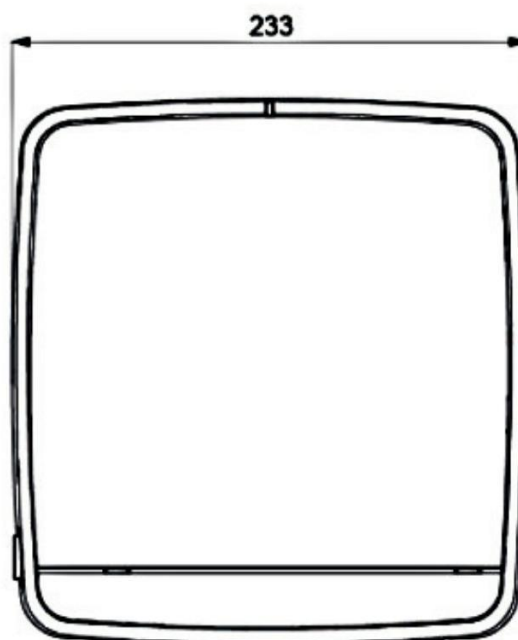
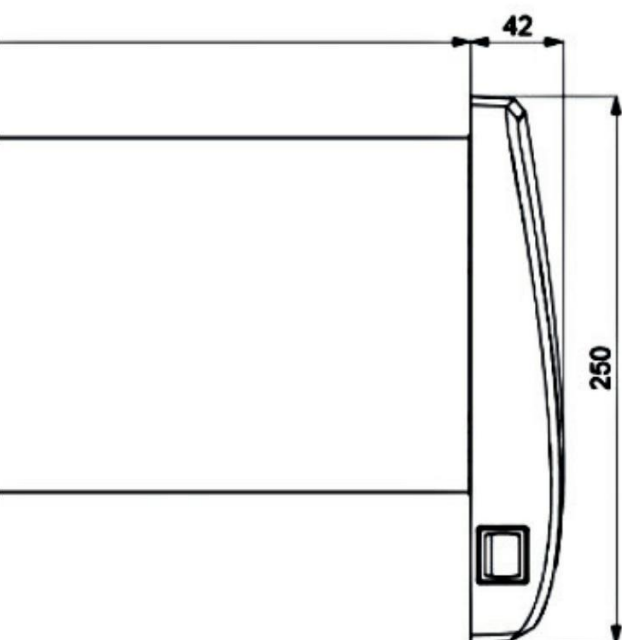

süd  **wind**

One of the quietest **ventilation** systems on the market.

termikamoldova@gmail.com

www.termika.md

+373 79 61 80 80